



MODULE 365

The ultimate combination - darts, accessories and dartboards, all displayed in one compact floor standing unit. For added security, the darts and accessories sections have separate locking security doors.

DARTS	60 Sets	UPPER DEPTH	11 cm
ACCESSORIES	300 Sets	BASE DEPTH	50 cm
BOARDS	10 pcs	HEIGHT	187 cm
EMPTY WEIGHT	31 kgs	WIDTH	49 cm



MODULE 160

The new increased capacity Module 160, featuring 6 extra facings for accessories, allows the retailer who is developing darts sales to display 40 sets of darts and 180 accessories.

DARTS	40 Sets
ACCESSORIES	180 Sets
HEIGHT	90 cm
WIDTH	46 cm
DEPTH	11 cm

For retail stockists, darts and accessories are a guaranteed consumer traffic builder, with players returning time after time. Year round sales, combined with exceptional margins, makes darts a truly dynamic profit centre.



MODULE 60

Module 60 is ideal for the retailer who wishes to stock in depth. 12 facings x 5 sets deep gives a 60 set capacity. Use in conjunction with Module 300 to create a comprehensive darts section.

DARTS	60 Sets	WIDTH	46 cm
HEIGHT	72 cm	DEPTH	11 cm



MODULE 300

For retailers concerned about theft of accessories, this locking unit is the perfect solution. 30 facings allow a wide variety of products to be viewed in areas where stealing is a problem.

ACCESSORIES	300 Sets	WIDTH	46 cm
HEIGHT	76 cm	DEPTH	11.5 cm

SLAT WALL HOOK



Ideal for fixing all wall hanging Modules to retail slat wall display systems. Hook fits key hole slots on the back of merchandising modules.

MAGNETIC HEADER

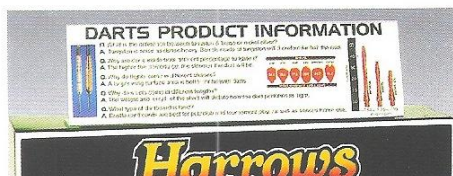

The Virtual Salesman! The display card answers the 5 most frequently asked consumer technical questions, thereby improving product knowledge, and increasing sales. Each header is held in place by magnetic strips and fits all modules.

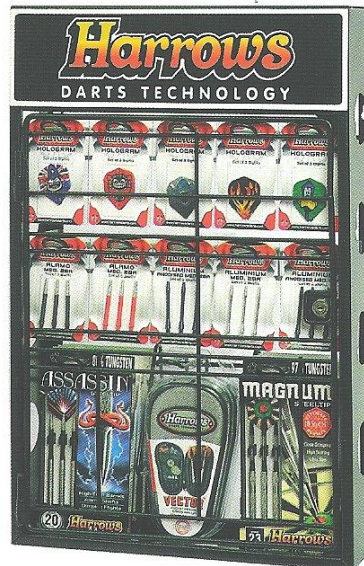

MODULE 115

The perfect starter merchandiser. As an introduction to the retailing of Harrows Darts, this unit provides the opportunity for the stockist to test the market, before making a further commitment to a larger merchandiser.

DARTS	15 Sets	HEIGHT	76 cm
ACCESSORIES	100 Sets	WIDTH	46 cm
		DEPTH	11.5 cm



BRISTOW GOLD 90% TUNGSTEN

Eric Bristow's unique achievements have established him as the name and the face of darts sport worldwide. The Bristow Gold series features high technology titanium tungsten barrels, which are engraved as a permanent reminder of the achievements of the man they call "The Crafty Cockney".

22gR
24gR
26gR

SPECIFICATIONS

MARATHON GOLD 2300

ELECTRO®

90% TUNGSTEN

STEEL



- Die klassischen Darts des 5-maligen Weltmeisters gibt es jetzt auch in der Titan-Wolfram-Ausführung.
- Los dardos clásicos del 5 veces campeón del mundo, con cuerpo de tungsteno en titanium dorado.
- Les traditionnelles fléchettes du quintuple Champion du Monde. Avec un obus et alliage Titanium Tungstene
- Klasyczne lotki pi_ciockrotnego mistrza _wiata, ze z_otymi tytanowo-wolframowymi korpusami.
- Tradiāni wolframové šípky 5-ti násobného Mistra svāta se speciālni povrchovou úpravou.

90% TUNGSTEN
47 World Titles

ERIC Bristow

A MARATHON GOLD
GOLD TITANIUM TUNGSTEN
STEEL TIP

CRAFTY COCKNEY

Eric Bristow "The Crafty Cockney" is the only professional player to be awarded the M.B.E. for his contribution to the sport of darts.

WEIGHT
26
GRAM

Harrow's
DARTS TECHNOLOGY



MAGNUM™ 97% TUNGSTEN

Tungsten is used in darts production because of its high weight to volume ratio. The higher the percentage of tungsten, the slimmer the dart will be. The Magnum precision knurled high density (18.5g/cm³) 97% tungsten is truly the ultimate dart.

21gK
23gK
25gK

SPECIFICATIONS

HOLOGRAM 1617

AZTEC®

97% TUNGSTEN

STEEL



- Durch den 97% igen Tungstenanteil ist dieser Dart extrem schlank und ermöglicht eine enge Platzierung der Darts.
- 97% de tungsteno caracterizado por el perfil de su cuerpo delgado, que facilita el agrupamiento.
- 97% de Tungstène donne au profil de la fléchette, plus de finesse pour de meilleurs groupés.
- 97% wolfram daje smukty profil i zapewnia maksymalną celność.
- Povrchová úprava a 97% wolframu dávají dohromady opravdu jedinečnou šípku.

97% TUNGSTEN

MAGNUM™

STEEL TIP

ULTIMATE DENSITY
18.5G/CM³

Close Grouping
High Scoring
Ultra Slim

WEIGHT
21
GRAM

Harrow's
DARTS TECHNOLOGY

STEEL TIP



21gK
23gK
25gK

22gK2
24gK2
26gK2

POWERPOINT® 80% TUNGSTEN

The "Powerpoint Kinetic Energy Principle" is a unique patented concept which dramatically reduces bounce outs and thereby increases scoring averages. The energy from the darts forward thrust forces the point into the board.

SPECIFICATIONS

HOLOGRAM 1636

ANODISED ALUMINIUM

80% TUNGSTEN

STEEL

- Das Powerpoint System reduziert Abpraller auf ein Minimum. Dadurch erzielt man eine höhere Punktzahl.
- El Sistema de Energia Powerpoint reduce drásticamente los rebotes, resultando en puntuaciones más altas y más oportunidades de ganar.
- Le système mécanique "Powerpoint" réduit considérablement les "refus", il en résulte de meilleurs scores et finitions.
- Wyjątkowy system Powerpoint zdecydowanie zmniejsza liczbę nietrafionych rzutów i prowadzi do uzyskania większej liczby punktów oraz zwiększenia szans na wygraną.
- Povrch a systém "Powerpoint" této šipky dává hráči větší možnost jistého skórování.



21gR

23gK

24gR

25gK

ATLANTIS™ 95% TUNGSTEN

The Atlantis 95% range is comprised of a series of barrels which have been designed and styled to maximise on the optimum scoring potential of high density tungsten (18.0g/cm3).

SPECIFICATIONS

GRAFLITE® 7000

ATLANTIS™

95% TUNGSTEN

STEEL

- Hochwertige Tungsten Darts in geringter und geriffelter Ausführung.
- Dardos de tungsteno de alta densidad en estilos anillados y grafilados.
- Haute densité de Tungstène dans une sélection de styles.
- 95% wolfram daje smukły profil i zapewnia maksymalną celność.
- Skvěle vyrobená wolframová šipka v několika provedeních.

Eric Bristow

BRISTOW 90% TUNGSTEN

Eric's 90% tungstens feature unique name engraving on the barrel, which acts as a permanent reminder of the Darts Legend. The parallel barrels optimise on the use of high density tungsten.

22gR
24gR
26gR

22gK
24gK
26gK





SPECIFICATIONS

DIMPLEX® 4003

AZTEC™

90% TUNGSTEN

STEEL

-  Die hochwertigen Darts des 5-maligen Weltmeisters Eric Bristow.
-  Los dardos de tungsteno del 5 veces campeón del Mundo.
-  Les fléchettes du quintuple Champion du Monde.
-  Oryginalne klasyczne korpusy lotek pięciokrotnego mistrza świata.
-  Unikátní tělo šípky navržené pětinasobným mistrem světa Ericem Bristowem.



STEELTIP



BOXER™ 90% TUNGSTEN

Boxer 90% feature groove and knurl configurations which give the player optimum "feel", combined with ease of release. 90% tungsten gives a competitive advantage to players who are serious about winning.

22gK1
24gK1
26gK1

21gK
23gK
25gK
27gK
29gK





SPECIFICATIONS

HOLOGRAM 1617

ALAMO®

90% TUNGSTEN

STEEL

-  Hochwertige schmale Tungsten Darts in verschiedenen Ausführungen.
-  Dardos de tungsteno de alta calidad en estilos anillados y grafilados.
-  Haute qualité de Tungstène dans un choix de différents profils.
-  Wysokiej jakości wolframowe lotki o różnorodnych stylowych kształtach.
-  Šípky s hladkým i drsným povrchem, což dává hráči možnost najít to, co jeho prstům vyhovuje.





21gR
25gR

23gR
27gR

V WING™ 90% TUNGSTEN

V Wing 90% tungsten darts are machined into a naturally contoured shape, giving the player a grip that is styled for maximum thrust, optimum control and precision in flight performance, time after time. The unique barrels are teamed with Gyro shafts, the top of which will rotate if a following dart makes contact.

SPECIFICATIONS

V WING™ 7709

GYRO™

90% TUNGSTEN

STEEL

● Durch die Griffmulde mit Rillen und die angeraute V Wing liegt dieser Dart sehr gut in der Hand.

● Perfil con contorno para un agarre firme y constante.

● Contour profilé pour une même et constante prise.

● Korpusy o dobranych konturach umożliwiają jednaki i zawsze dający się powtórzyć chwyt.

● Unikátně tvarovaná šípka se zdrsnením v přední části.



21gR
23gR
25gR

FLASH™ 90% TUNGSTEN

World Masters Champion Mark "Flash" Dudbridge's 90% Tungsten precision engineered darts feature micro-grip technology, which gives a unique non-slip grip, combined with ease of release, for ultimate control. Hi-Tech shafts and "Flash" flights provide World Class performance.

SPECIFICATIONS

HOLOGRAM 1649

NYLON

90% TUNGSTEN

STEEL

● World Masters Champion Darts mit speziellem Micro Schliff.

● Los dardos de los campeones del mundo tienen un único y preciso agarre.

● Les flechettes du Champion "World Master" avec un grip unique de precision.

● Oryginalne lotki mistrza świata wykorzystujące technikę mikro-przyczepności.

● Šípky charakteristické svými úzkými rovnými těly pro přesné skórování.



GRAFLITE™ 80% TUNGSTEN

Graflite Tungstens are made from a unique sintered carbon toughened alloy, which allows the darts to be aggressively knurled, giving a non-slip grip over the entire length of the barrel. Hi-Tech shafts are combined with revolutionary micro-fibre technology flights for extreme darts sport performance.

22gK
24gK
26gK

SPECIFICATIONS

GRAFLITE™ 7000

ATLANTIS™

80% TUNGSTEN

STEEL

- Extrem geriffelter Tungsten Dart mit Atlantis Shafts und neuen Graflites.
- Ofrece aleación endurecida de carbón para un extremo y antideslizante agarre.
- Caractérisé par un alliage de carbone très résistant pour un grip extrême.
- Oryginalne klasyczne korpusy lotek pięciokrotnego mistrza świata.
- Šipky s vysoce neklouzavým povrchem.

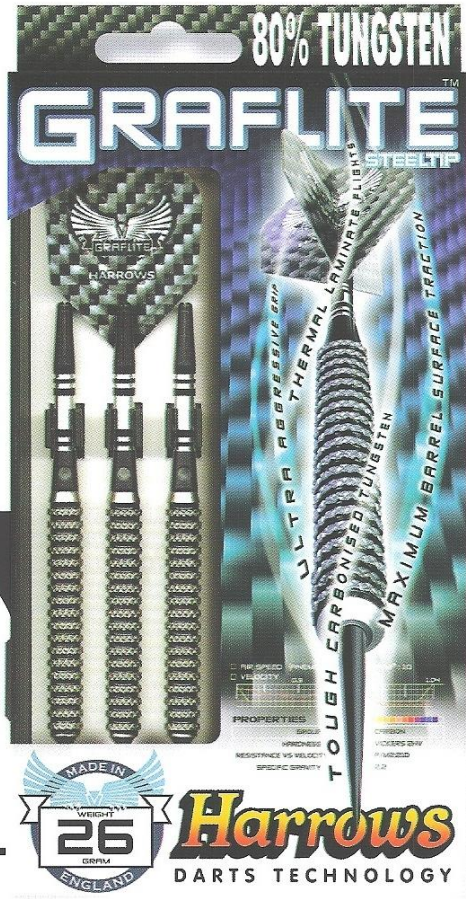

STEELTIP



SAVAGE™ 80% TUNGSTEN

Computer analysis of players preferred dart grip shows that the majority hold the barrel on the front and rear sections. Savage darts feature two black knurls which have been positioned to give the player positive feedback from the grip zone.

19gK
21gK
23gK
25gK
27gK
29gK

SPECIFICATIONS

HOLOGRAM 1633

ALAMO®

80% TUNGSTEN

STEEL

- Zwei schwarzgeriffelte Abschnitte schaffen besseren Griff.
- Dos grafiados negros estratégicamente posicionados dan más respuesta y control.
- Deux molettes noires positionnées, stratégiquement, donne un supplément de contrôle.
- Dwie czarne strefy chwytu dla uzyskania maksymalnej sterowności.
- Dvojí černé zdrsnění zvyšuje jistotu uchopení.



80% TUNGSTEN

80% TUNGSTEN NICKEL
TUNGSTENE NICKEL

ALIEN™
STEEL TIP

UNIQUE GRIP BARREL
HI TECH SHAFTS
FANTAIL FLIGHTS
SLIMPACK CASE

WICKOFF
23
GRAM

Harrow's
DARTS TECHNOLOGY

21gR
23gR
25gR
27gR



ALIEN™
80% TUNGSTEN

Alien 80% tungstens feature classic contoured barrels, whose symmetrical shape allows the player to control the front and rear of the dart, right up until the moment of release. Alamo shafts and spooky Alien flights take these darts to a different dimension.

SPECIFICATIONS

FANTAIL™ 3004

Die klassische Tropfenform zeichnet diesen dart aus.

ALAMO™

Una combinacion de estilo y exactitud proporciona el mejor resultado para el jugador mas exigente.

80% TUNGSTEN

Flechette de style traditionnel pour les joueurs qui desirent plus de controle et de performance.

STEEL

Klasyczny profil konturowy dla uzyskania maksymalnej sterownosci.

Unikátne tvarovaná sipka se zdrsnením v prední části.

80% TUNGSTEN

GYRO™
STEEL TIP

gyro spintop shafts
extra grip barrels
high - tec flights
slimpack case

WEIGHT
20
GRAM

Harrow's
DARTS TECHNOLOGY

20gK
22gK
24gK
26gK
28gK

21gR
23gR
25gR



GYRO™
80% TUNGSTEN

Gyro 80% tungstens feature truly unique balanced barrels with EGP (Extra grip performance). If a following dart makes contact with the spinning top of the Gyro shaft, then the top will rotate, allowing clear tracking into the board, resulting in reduced deflections and optimised scoring opportunities.

SPECIFICATIONS

HOLOGRAM 1603

Schmale Dartkörper mit drehbaren Gyro Shafts.

GYRO™

Cuerpos lisos y cañas "Gyro" con borde superior giratorio.

80% TUNGSTEN

Un corps profilé avec des tiges Gyro rotatives.

STEEL

Nowatorski korpus polaczoney z obrotowymi końcówkami.

Sípky s rotacními násadkami.



18gR

19gK

20gR

21gR

22gK

22gR

23gK

23gR

24gK

24gR

25gK

25gR

26gK

27gR

28gK

29gK

30gR

31gK

32gR

34gK

36gR

38gK

40gR

STANDARD RANGE

HEAVY RANGE

STEELTIP

80% TUNGSTEN

ASSASSIN[®]

STEELTIP

High-Tech Barrels
Alamo Shafts
Dimplex Flights
Slimpack Case

WEIGHT
23
GRAM

Harrows

DARTS TECHNOLOGY



ASSASSIN[®] 80% TUNGSTEN

The world's most popular tungsten darts. The Assassin 80% range offers a fully comprehensive selection of styles and weights, which combine to form a series of radical and highly popular patterns. Alamo shafts and Dimplex flights provide aerodynamic perfection.

SPECIFICATIONS

- Diese bekannten 80% Tungsten Darts gibt es in vielen Gewichten und Formen.
- La serie de 80% Tungsteno más popular del mundo, disponible en una amplia gama de peso y estilos.
- La gamme des 80% de Tungstène, la plus populaire au monde, est disponible dans un large choix de poids et de styles.
- Najpopularniejsze na świecie wolframowe lotki są dostępne w szerokim asortymencie pod względem ciężaru i rodzaju korpusu.
- Vynikající a velmi populární výber 80% wolframových šipek v mnoha hmotnostech a provedeních.

70% TUNGSTEN

TORPEDO
STEEL TIP

HI-TECH BARRELS
QUALITY SHAFTS
HI TECH FLIGHTS
SLIMPACH CASE

PRECISION ENGINEERED
WEIGHT **23** GRAM

Harrow's
DARTS TECHNOLOGY



TORPEDOTM
70% TUNGSTEN

Torpedo tungstens feature parallel barrels for close grouping. Nylon shafts with flight retaining ring grips are teamed with patented Dimplex flights, creating an intermediate priced series for the developing player.

SPECIFICATIONS

- DIMPLEX® 4025** Einsteiger Tungsten Darts mit schmalen Dartkörper.
- NYLON** Los dardos Torpedo tienen barriles paralelos para un agrupamiento más cercano.
- 70% TUNGSTEN** Les flechettes Torpedo avec une taille de grip identique pour des finish groupes.
- STEEL** Wolframowe lotki przeznaczone dla początkującego gracza.
- Profesionální sipky pro jedinečné přesné uchopení.

STEEL TIP

BLACK JACK

Repolytamic Performance Rating: CRITICAL
Flight response Monitor: 4388 Stability control Test: Press 100%

GRAFLITE™ HARROWS

FLIGHT TESTED
DIGITALLY BALANCED

WEIGHT **24** GRAM

Harrow's
DARTS TECHNOLOGY



BLACK JACKTM
STAINLESS STEEL

The Black Jack range is a sleek and menacing series for the advancing player. The "tungsten look" barrels feature precision black knurling, for maximum grip and optimum control. The barrels are teamed with the very latest advances in shaft and flight technology.

SPECIFICATIONS

- GRAFLITE™ 7000** Grossartige Darts der Mittelklasse im Tungsten-Look für den fortgeschrittenen Spieler. Die schwarzgeriffelten Abschnitte machen die Darts griffiger.
- ANODISED ALUMINIUM** Serie de dardos semejante al tungsteno a un precio intermedio para el jugador avanzado.
- STAINLESS STEEL** Une superbe serie de flechettes a prix interemediare au look tungstene pour tous les joueurs .
- STEEL** Wspaniała seria lotek w _redniej cenie, przypominaj_cych wygl_ dem lotki wolframowe, dla zaawansowanych graczy.
- Nová fiada Sípek wolframového vzhledu ve skvůle ceně.



VOODOO™ BRASS

The Voodoo range of superbly styled brass darts features unique black knurled barrels, which are designed to give optimum grip and control. Anodised aluminium shafts, teamed with aerodynamic Dimplex flights combine to create perfection in flight.

19gK
21gK
23gK
25gK
27gK

SPECIFICATIONS

DIMPLEX® 4046

Das ausgefallene Design und die schwarzen Griffzonen zeichnen diesen Dart aus.

ANODISED ALUMINIUM

Espléndidos cuerpos con un estilo característico que presentan zonas negras de agarre único.

BRASS

De superbes corps stylisés, caractérisés par des zones de prise constante.

STEEL

Doskonały rodzaj uchwytu dla uzyskania dodatkowej sterowności i zdobycia dużej liczby punktów.

Zajímavé barvená mosazná šípka se zdrsneným povrchem.



STEEL TIP

ERIC BRISTOW SILVER ARROWS

The 5 times World Champion's Silver Arrow series is styled on his tournament winning tungstens and it gives the advancing player a chance to repeat the Crafty Cockney's achievements, at an intermediate price.

18gR
22gR
26gR

SPECIFICATIONS

DIMPLEX® 4003

Die verchromten Darts der mittleren Preisklasse sind den Darts des 5-fachen Weltmeisters nachempfunden.

ALAMO®

Serie cromada de precio medio, inspirada en los dardos 5 veces campeón del mundo.

CHROMED BRASS

La série "chrome" du quintuple Champion du Monde.

STEEL

Seria „styl chromowany” pięciokrotnego mistrza świata, legendy gry w darta.

Chromované mosazné šípky vyrobené ve stylu tech, se kterými pětinásobný mistr světa vyhrál všechny světové turnaje.





BLACK ARROW™
STEELTIP

EBONITE BARRELS
HI-TECH SHAFTS
HOLOGRAM FLIGHTS
SLIMPACK CASE

WEIGHT
19
GRAM

Harrows
DARTS TECHNOLOGY



23gK

24gR

25gK

26gR

BLACK ARROW™ EBONITE BRASS

The Black Arrow range appeals to players of all ages and abilities. The brass barrels are ebonite coated to achieve a look of great style and distinction and they are available in a wide selection of models.





SPECIFICATIONS

HOLOGRAM 1643

ALAMO™

EBONITE BRASS

STEEL

-  BLACK ARROW Darts, ideal für den Freizeitspieler.
-  Gama de cromados negros, lisos y estilizados para el jugador intermedio.
-  Une luisante et stylée série de "Black" chromée pour développer votre Technique de Jeu.
-  Stylowe czarne korpusy dla gracza pragnącego rozwinąć swoją technikę.
-  V yber tejto sipek m'uze oslovit hráce vseh úrovní.



MATRIX™
STEELTIP

CONTOURED BARRELS
HOLOGRAM FLIGHTS
HI TECH SHAFTS

WEIGHT
26
GRAM

Harrows
DARTS TECHNOLOGY

20gK
22gK
24gK
26gK

MATRIX™ SCALLOPED BRASS

The Matrix range of superbly styled brass darts feature unique colour coded, contoured barrels, which are designed to give optimum grip and consistent, repeatable control. High tech shafts teamed with aerodynamic flights combine to create "in flight" perfection.





SPECIFICATIONS

HOLOGRAM 1613

NYLON

BRASS

STEEL

-  Durch die Griffmulde mit Rillen und die angeraute Zone liegt dieser Dart sehr gut in der Hand.
-  Su contorno y forma permite un continuo agarre y control.
-  Super contour avec gripp pour une meilleure prise et un excellent controle.
-  Lotki o dokonalým kšatčie konturovým dla niezmiennego uchwytu i sterowności.
-  Sipky charakteristické skvľ m tvarem túla a vysokou kontrolou hodu.

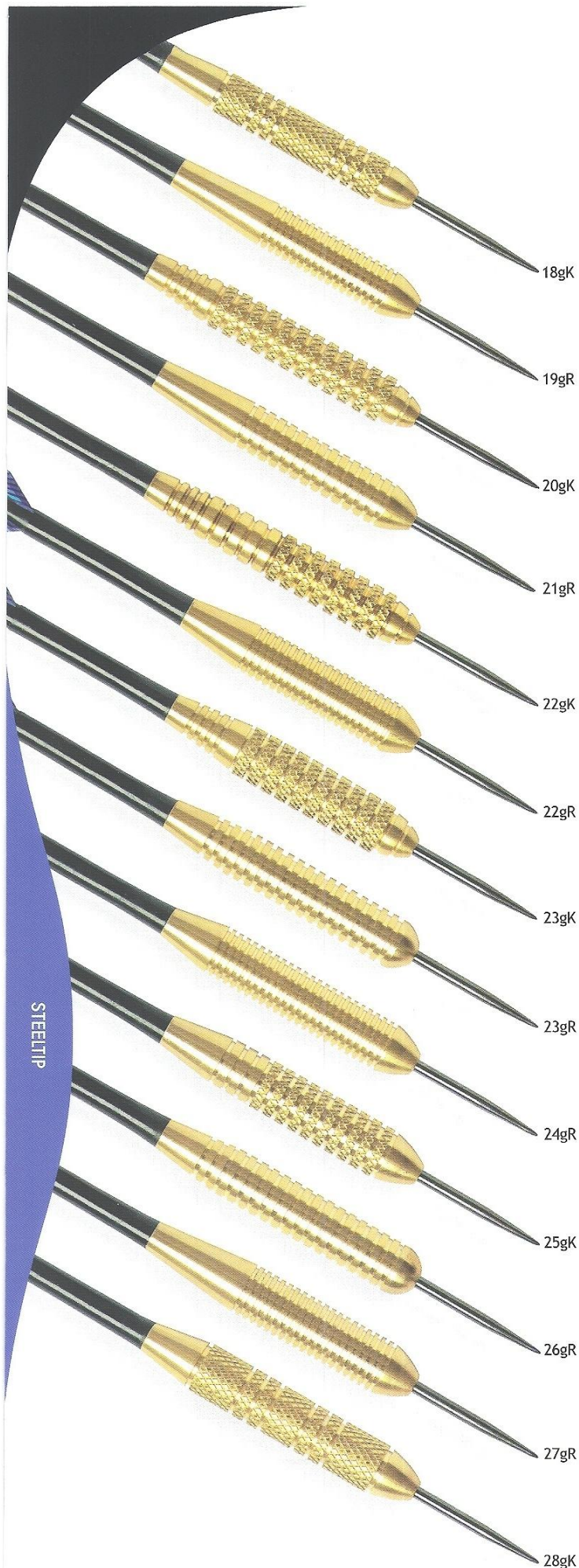

STEELTIP

18gK

19gR

20gK

21gR

22gK

22gR

23gK

23gR

24gR

25gK

26gR

27gR

28gK



CLUB BRASS

The Club range is the worlds most popular brass series. The precision barrels, which are available in a wide choice of weights and styles, are teamed with nylon shafts and Hologram flights for great all round performance.

SPECIFICATIONS	
HOLOGRAM 1620	
NYLON	
BRASS	
STEEL	

-  Günstige Messing Darts, komplett mit schwarzen Alu-Shafts und Hologram Flights.
-  Una extensa gama de dardos de latón con aletas Hologram.
-  Une gamme complète de fléchettes laiton avec des ailettes Hologram..
-  Najpopularniejsze na świecie mosiężne lotki są dostępne w szerokim asortymencie pod względem ciężaru i rodzaju korpusu.
-  Nabídka velice kvalitních a levných mosazných sipek v mnoha hmotnostech a provedeních.



MAGNUMTM 97% TUNGSTEN

16gK
18gK

Tungsten is used in darts production because of its high weight to volume ratio. The higher the percentage of tungsten, the slimmer the dart will be. The Magnum precision knurled high density (18.5g/cm³) 97% tungsten is truly the ultimate dart.

SPECIFICATIONS

FANTAIL® 3010



● Durch den 97% igen Tungstenanteil ist dieser Dart extrem schlank und ermöglicht eine enge Platzierung der Darts.

AZTEC™



● 97% de tungsteno caracterizado por el perfil de sus cuerpos delgados, que facilita el agrupamiento.

97% TUNGSTEN



● 97% de Tungstène donne au profil de la fléchette, plus de finesse pour de meilleurs groupés.

SOFT



● Korpusy z wolframu o wyjątkowo dużej gęstości przeznaczone do uzyskania dobrego skupienia i dużej liczby punktów.

● Sipka s 97% wolframu patri k tem nej kvalitnejším.



WEIGHT
18
GRAM

Harrows
DARTS TECHNOLOGY

SOFTIP



ATLANTISTM 95% TUNGSTEN

16gK
18gK
20gK

Atlantis 95% darts have been designed and styled to maximise on the optimum scoring potential of high density tungsten (18.0g/cm³). Atlantis shafts and Combat flights offer balanced perfection.

SPECIFICATIONS

COMBAT™9911



● Herausragende Darts aus 95% Tungsten mit extra schmalen Dartkörper.

ATLANTIS™



● 95% alta densidad Tungsteno con un agarre único. Cuerpo extra fino.

95% TUNGSTEN



● Une densité de 95% de tungstène avec "prise unique" sur un corps ultra fin.

SOFT



● Super cienkie wolframowe korpusy przeznaczone do uzyskania maksymalnego skupienia i dużej liczby punktów.

● 95% wolframu a zpracování sipky zaručuje možnost vysokého skórování.

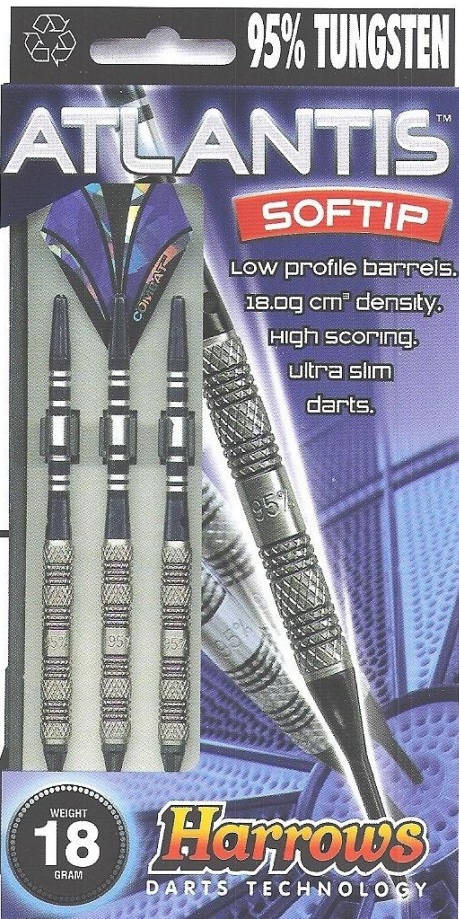

WEIGHT
18
GRAM

Harrows
DARTS TECHNOLOGY



Style B: 18gR
20gR

Style C: 18gR
20gR

VORTEX™ 90% TUNGSTEN GOLD

Give the player ultimate control with these high technology aerodynamic Vortex 90% tungsten darts. The laser engraved, frontally loaded barrels feature 45° Reverse Grip Zones (RGZ). The Gold Titanium Tungsten barrels are combined with high technology flights and shafts for ultimate performance.

SPECIFICATIONS

MARATHON® GOLD 2300

GRAFILITE® SHAFTS

90% TUNGSTEN

SOFT

Einzigartig geformte Darts aus Titanium Tungsten "Gold"

Juego de dados de forma unica con cuerpo de Tungsteno Titanio "Oro"

De superbes corps stylisés, avec obuts de titanium tungstene "Gold".

Nowoczesne lotki ze złotymi tytanowymi korpusami s[ł]u[ż]ą do uzyskania najwy[ż]szej dokładności.

Špičková technologie pro dokonalý tvar a vzhled se speciální povrchovou úpravou „Gold titanium“.

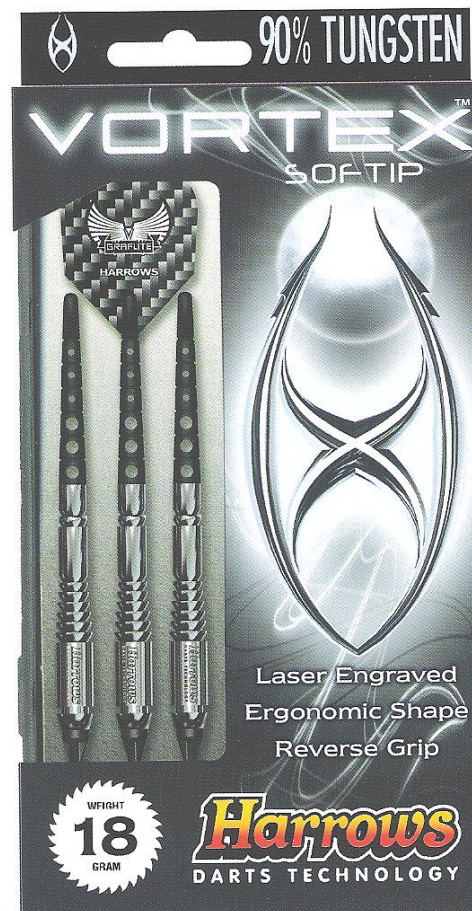

Style A: 16gR
18gR
20gR

Style B: 18gR
20gR

Style C: 18gR
20gR

Style D: 18gR
20gR

VORTEX 90% TUNGSTEN

Truly unique grip darts for the player who is serious about winning!

SPECIFICATIONS

GRAFILITE™ 7000

GRAFILITE®

90% TUNGSTEN

SOFT

Perfekt geformte Darts für einen perfekten Wurf.

Cuerpos con un perfil de contorno fantástico para un maximo control.

Flechettes de haute technologie avec obus profiles pour joueurs serieuse.

Nowoczesne lotki s[ł]u[ż]ą do uzyskania wyników o najwy[ż]szej dokładności

Špičková technologie pro dokonalý tvar a vzhled.



Eric Bristow

BRISTOW™ 95% TUNGSTEN

Eric's ultimate high density softip darts are made to the precision specifications that the "Crafty Cockney" demands. Aztec shafts and Combat flights provide perfection in flight.

16gK
18gK
20gK

16gR
18gR
20gR

SPECIFICATIONS

COMBAT™ 9910



Die hochwertigen Darts des 5 - maligen Weltmeisters Eric Bristow werden in 2 Ausführungen angeboten.

AZTEC™



Los dardos de tungsteno del 5 veces campeón del mundo se presentan en dos modelos diferentes.

95% TUNGSTEN



Les fléchettes du quintuple Champion du Monde sont fabriquées en deux modèles.

SOFT



Klasyczne lotki pięciokrotnego mistrza świata są dostępne w dwóch rodzajach korpusu.

Dva typy sipek vyrobené podle predstav petinásobného mistra sveta Erica Bristowa.



ZONE™ 90% TUNGSTEN

The unique barrel profile of Zone 90% tungstens is the result of extensive research into the preferred grip of players who are serious about winning. The "Contour Zone" assists in achieving a consistent grip, thereby giving the player a constantly repeatable dart release.

16gK
18gK

SPECIFICATIONS

V WING™ 7709



Durch die "Contour Zone" wird der Dartkörper griffiger.

AZTEC®



La "Zona de Contorno" da a los cuerpos grafitados un agarre consistente para mayor control.

90% TUNGSTEN



Le contour "Zone" donne au corps une même et constante prise pour un surcroît de maîtrise.

SOFT



Strefa konturu umożliwia stały powtarzający się chwyt dla uzyskania maksymalnej sterowności.

Tvar a prední zdrsnění sipyk umožňuje při hodu prst* um hráče její dobrou kontrolu.



OPEN
HERE

ECOLOGY NOTE:
PRINTED ON
RECYCLED
PAPER.

80% TUNGSTEN NICKEL
TUNGSTENE NICKEL

DIMPLEX
SOFTIP

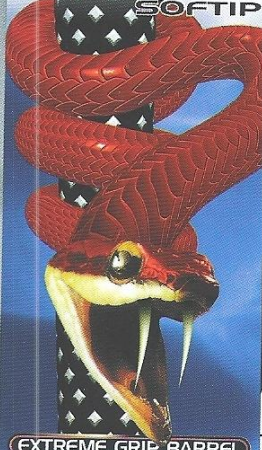

EXTREME GRIP BARREL
AZTEC™ SHAFTS
VORTEX 353™ FLIGHTS
SLIMPACK CASE

WEIGHT

18

GRAM

Harrow's
DARTS TECHNOLOGY

16g
18g



DIMPLEX™
80% TUNGSTEN

The barrels of the latest generation of Dimplex darts give the player an easier "throw release", whilst maintaining the overall grip characteristics that have popularised this truly unique concept. Aztec shafts and Vortex 353 flights create perfection "in flight".

SPECIFICATIONS

VORTEX® 353™ 130Z

AZTEC™

80% TUNGSTEN

SOFT



Der griffige Dartkörper garantiert erstklassige Handhabung.



Cuerpo de agarre único para el mejor control.



Un supplément unique d'adhérence pour un contrôle de prise optimum.



Wyjątkowy chwyt dla maksymalnej sterowności.



Sipka s velmi drsným povrchem zajistí ujitím její jisté uchopení.



OPEN
HERE

ECOLOGY NOTE:
PRINTED ON
RECYCLED
PAPER.

MAGNETIC
80% TUNGSTEN

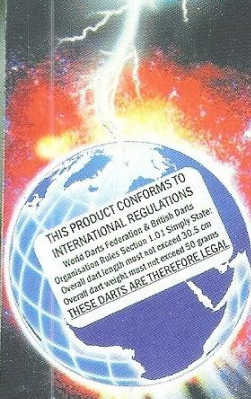

MAGNETIZED BARRELS
INFINITE POWER SOURCE
CLOSER GROUPING
WORLD PATENTS PENDING

SOFTIP

WEIGHT
18

GRAM

Harrow's
DARTS TECHNOLOGY
World Patents Pending

16gK
18gK
20gK



MAGNETIC™
80% TUNGSTEN

Magnetic Tungstens are a revolution in Darts Technology. The player will feel the difference in their game when the awesome power of the magnetised [NdFeB] barrels comes into play. The magnetism of the barrels is covered by a lifetime guarantee.

SPECIFICATIONS

COMBAT™ 9916

TEKNALITE™

80% TUNGSTEN

SOFT



Das erstaunliche neue High-Technology-Konzept. Magnetische Dartkörper für eine höhere Punktzahl. Der Magnetismus hat eine lebenslange Garantie.



Asombroso concepto de la nueva alta tecnología. Cuerpos magnéticos para alta puntuación. El magnetismo garantiza una utilización duradera del cuerpo.



L'incroyable nouvelle technologie. Obus magnétique pour des scores plus élevés. Système magnétique garanti à vie.



Niesamowite korpusy lotek Magnetic przeznaczone do uzyskania dobrego skupienia i dużej liczby punktów. Magnetyzm gwarantowany dożywotnio.



Ohromující pojetí nové technologie. Magnetická těla šipek pro vyšší skórování. Doživotní záruka na magnetismus.



FLASH™ 90% TUNGSTEN

16gK
18gK
20gK

World Masters Champion Mark "Flash" Dudbridge's 90% Tungsten precision engineered darts feature micro-grip technology, which gives a unique non-slip grip, combined with ease of release, for ultimate control. Hi-Tech shafts and "Flash" flights provide World Class performance!

SPECIFICATIONS

HOLOGRAM 1649

TEKNALITE™

90% TUNGSTEN

SOFT

- World Masters Champion Darts mit speziellem Micro Schliff.
- Los dardos de los campeones del mundo tienen un único y preciso agarre.
- Les flechettes du Champion "World Master" avec un grip unique de précision.
- Klasyczne lotki mistrza świata wykorzystujące technikę mikro-przyczepności.
- Šipky charakteristické svými úzkými rovnými tely pro přesné skórování.



NON SLIP TECHNOLOGY

MICRO GRIP BARRELS

QUALITY SHAFTS

FLASH FLIGHTS

WEIGHT
18
GRAM

Harrows
DARTS TECHNOLOGY

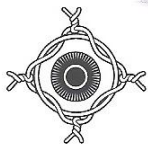

CYBORG™ 80% TUNGSTEN

16gK
18gK
20gK

Harrows robotically controlled production systems have created a symmetrical barrel profile, which gives the player an automatic winning advantage. Aztec shafts and Hologram flights combine to create a dart of exceptional balance.

SPECIFICATIONS

HOLOGRAM 1647

AZTEC™

80% TUNGSTEN

SOFT

- Die kurze Form zeichnet diesen Dart aus. Geriffelte Abschnitte schaffen besseren Griff.
- Proporciona un control absoluto debido a su equilibrio y su disen_o optimizado
- Superbe flechette au shaft "Minimum" a L'equilibrage precis pour un controle parfait.
- Klasyczny krótszy korpus dla uzyskania najwyższej sterowności.
- Nádherná, anatomicky tvarovaná a přesne vyvážená tela šipek pro absolutní kontrolu hodu



Finest quality softip darts made
to professional specifications
by the worlds leading supplier
to the champions

WEIGHT
18
GRAM

Harrows
DARTS TECHNOLOGY

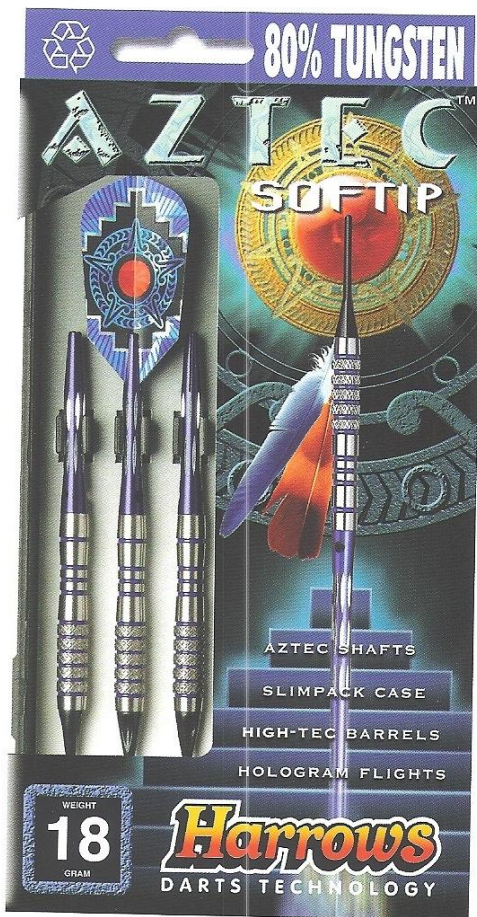

AZTEC™ 80% TUNGSTEN

The worlds most popular softtip tungsten darts.
The radically styled Aztec range is now available in a choice
of 9 models. Aztec shafts and Hologram flights create
aerodynamic perfection.

SPECIFICATIONS	
HOLOGRAM 1640	
AZTEC™	
80% TUNGSTEN	
SOFT	

- Welweit unübertroffen, der Aztec Dart, in 9 sehr beliebten Ausführungen.
- Los insuperables dardos Aztec, en 9 estilos muy conocidos.
- Les fléchettes Aztec, mondialement connues dans les 9 styles les plus populaires.
- Najpopularniejsze na świecie wolframowe lotki są dostępne w 9 różnych rodzajach korpusu.
- AZTEC - radikálne zpracovaná a patrne najpopulárnejší šípka se nyní nabízí ve 9 modelech.

14gK1

16gR

16gK

16gK1

18gR

18gK

18gK1

18gK2

20gK

SOFTIP

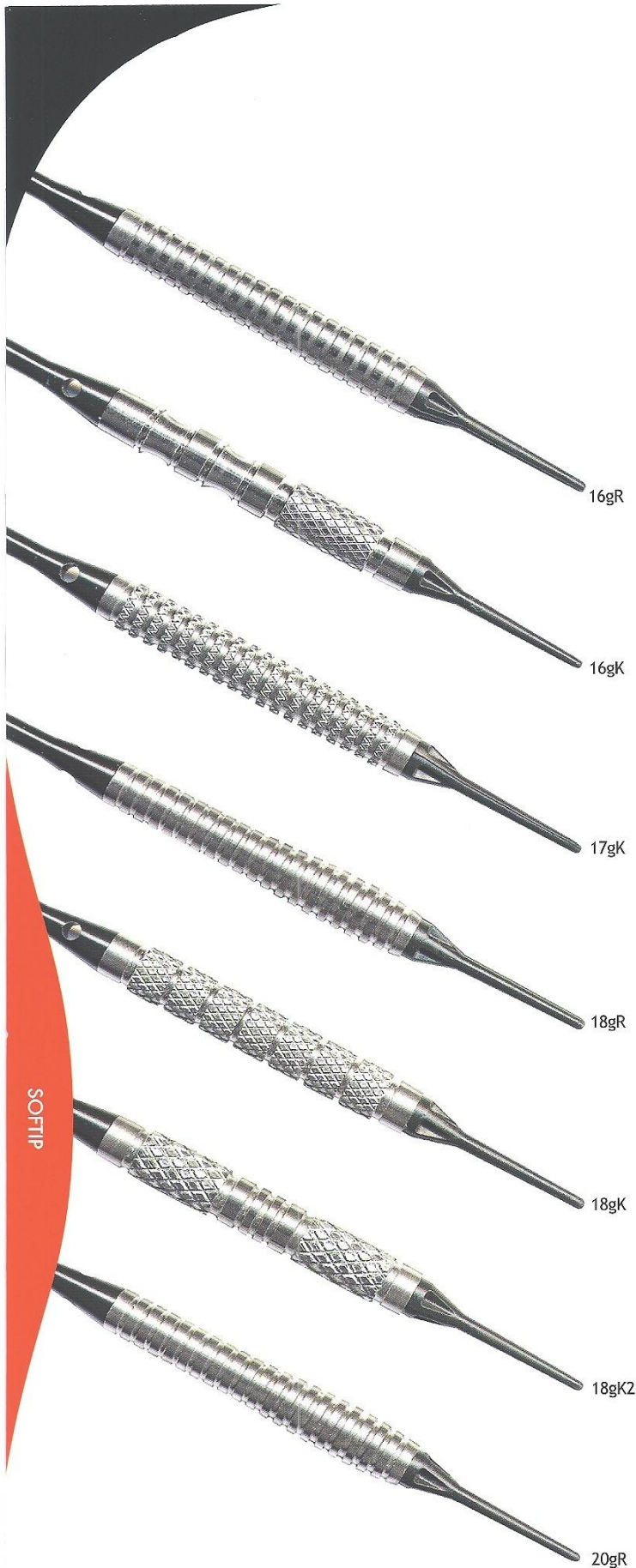

80% TUNGSTEN

ASSASSIN™

SOFTIP

PRECISION BARRELS
QUALITY SHAFTS
HI-TECH FLIGHTS
SLIMPACK CASE

WEIGHT 18 GRAM

Harrow's

DARTS TECHNOLOGY

ASSASSIN™

80% TUNGSTEN

The Assassin 80% range offers a fully comprehensive selection of styles and weights, which combine to form a series of radical and highly popular patterns. Anodised aluminium shafts and Graflite flights complete the line up.

SPECIFICATIONS

GRAFLITE™ 7001

ANODISED ALUMINIUM

80% TUNGSTEN

SOFT

- Diese bekannten 80% Tungsten Darts gibt es in vielen Gewichten und Formen.
- La gama de 80% Tungsteno más popular del mundo, disponible en una amplia gama de pesos y estilos.
- La gamme des 80% de Tungstène, la plus populaire au monde, est disponible dans un large choix de poids et de styles.
- Wspaniała kolekcja profesjonalnych lotek. Do wyboru 7 różnych modeli.
- Nabídka velice kvalitních a levných mosazných šipek v mnoha hmotnostech a provedeních.



16gK
18gK
20gK



NEMESIS™ 80% TUNGSTEN

The Nemesis range of precision softtips gives the player a truly aggressive grip experience. The tungsten barrels have a grip factor of 100% and they are ergonomically designed to suit all throwing techniques.

SPECIFICATIONS

HOLOGRAM 1631

SAVAGE™

80% TUNGSTEN

SOFT

 Der griffige Dartkörper/shaft garantiert erstklassige Handhabung.

 Esta gama de dardos de precisión combinan un agarre perfecto sobre cuerpos muy finos

 L'unique flechette au corps fin et recouvert de grip pour une adhérence totale.

 Wolframowe korpusy o smukłej linii z super uchwytem do ostrej gry.

 Super přesná, stihlá tela šipek s unikátním povrchem

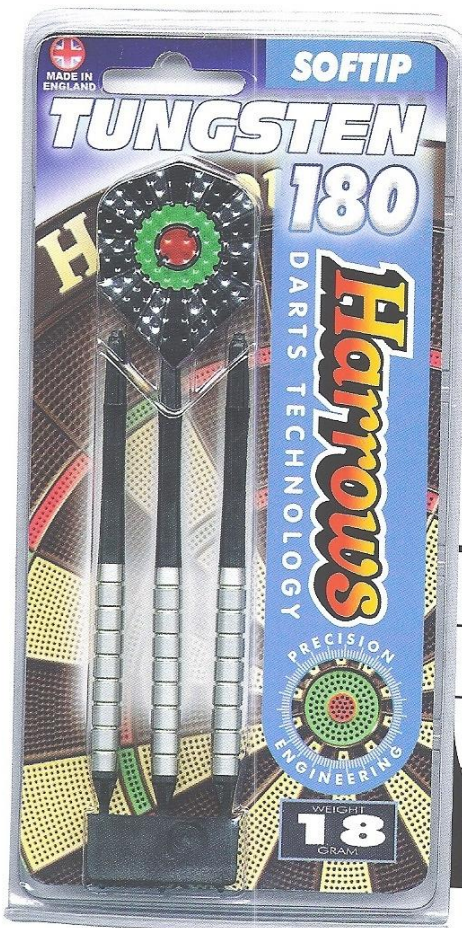

16gR
18gR

TUNGSTEN 180 PRECISION TUNGSTEN

Tungsten 180's are the ideal introduction to the world of Tungsten Darts Technology (T.D.T.) For the developing player, precision made Tungsten 180's offer the "Tungsten Experience" at an affordable price.

SPECIFICATIONS

DIMPLEX® 4016

NYLON

TUNGSTEN

SOFT

 Tungsten 180 sind der ideale Einstieg in die Welt der Tungsten Darts.

 Cuerpos grafilados Tungsten 180, la introducción ideal al mundo de la tecnología en dardos de tungsteno.

 La Tungsten 180 est l'introduction idéale au monde de la Technologie Tungstène.

 Idealne wprowadzenie do świata techniki wolframowych lotek po przystępnej cenie.

 Ideální ke vstupu do světa wolframových šipek.

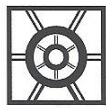

VECTOR™ STAINLESS STEEL

The Vector range features truly unique colour coded slimline barrels, which are teamed with anodised aluminium shafts and V Wing flights, to create the "Tungsten Look" for the advancing player.

SPECIFICATIONS

V WING™ 7709

ANODISED ALUMINIUM

NICKEL PLATE

SOFT

-  Designer Dart in klassischer Form.
-  Cuerpos ultra lisos para la mejor puntuación.
-  Un corps extrêmement profilé pour optimiser vos résultats.
-  Charakterystyczny „wolframowy wygląd” dla początkującego gracza.
-  Šipka se zajímave zdoobenými tely.

BLACK
16gK
18gK

RED
16gK
18gK



SOFTIP



Tiger darts feature stunning barrels, which offer increased grip and they are teamed with aluminium shafts and Hologram flights for added visual impact.





SPECIFICATIONS

HOLOGRAM 1645

ANODISED ALUMINIUM

BRASS

SOFT

-  Das ausgefallene Design und die schwarzen Griffzonen zeichnen diesen Dart aus.
-  Espléndidos cuerpos con un estilo característico que presentan zonas negras de agarre único.
-  De superbes corps stylisés, caractérisés par des zones de prise constante.
-  Doskonałe mosiężne korpusy z kompletnym pełnym chwytem.
-  Atraktivní drážkovaná mosazná těla šipek s dokonale sladenou násadkou a letkou.

14gR
16gR
18gR

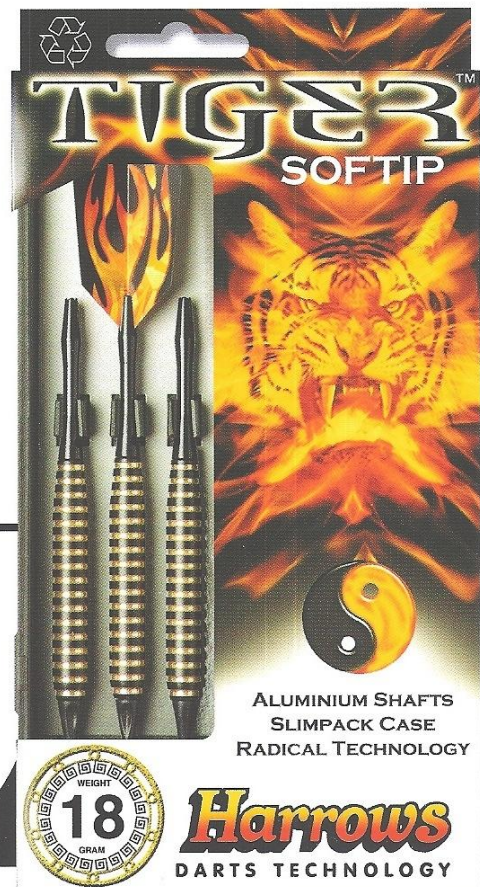

SILVER ARROW™ CHROMED BRASS

The Silver Arrow range features precision brass barrels which are finished with an elite silver chrome to create a stylish look for the intermediate player. Teknalite shafts and Hologram flights complete the winning formula.





SPECIFICATIONS

HOLOGRAM 1648

TEKNALITE™

CHROMED BRASS

SOFT

-  Verchromte Messing-Dartkörper verleihen der Silver Serie ein stilvolles Aussehen.
-  Serie lisa y con estilo para el jugador intermedio.
-  Une luisante et stylée série pour joueurs de tous niveaux.
-  Super stylowa seria chromowana dla zaawansowanego gracza dostępna w 3 fasonach.
-  Mosazné chromované sipky dobre použiteľné pro začátečníky i pokročilé.

16gK2
18gK2

16gR
18gR

14gK
16gK
18gK



DYNAMIC BARRELS

PRECISION SHAFTS

HI TECH FLIGHTS

SLIMPACK CASE



Harrows
DARTS TECHNOLOGY

SOFTIP

BLACK ARROW™ EBONITE BRASS

The Black Arrow range of ebonite coated brass darts presents a sleek and menacing image for the advancing player, who wishes to develop playing technique before upgrading to more advanced concepts. Anodised aluminium shafts teamed with V Wing flights provide balanced perfection.





SPECIFICATIONS

V WING™ 7703

ANODISED ALUMINIUM

EBONITE BRASS

SOFT

-  BLACK ARROW Darts, ideal für den Freizeitspieler.
-  Gama de cromados negros, lisos y estilizados para el jugador intermedio.
-  Une luisante et stylée série de "Black Arrow" pour développer votre Technique de Jeu.
-  Czarne mosiężne korpusy pokryte ebonitem idealne dla początkującego gracza.
-  Sipky s atraktivním designem, ideální pro začátečníky.

16gK2
18gK2

16gR
18gR

14gK
16gK
18gK

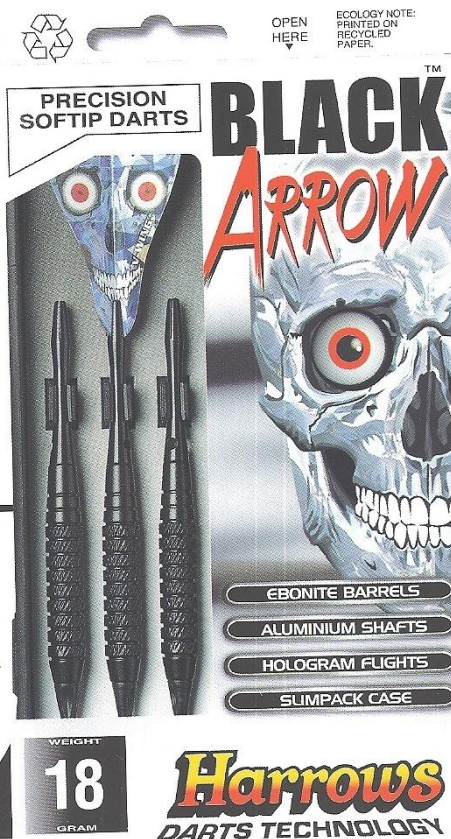

PRECISION SOFTIP DARTS

BLACK ARROW™

EBONITE BARRELS

ALUMINIUM SHAFTS

HOLOGRAM FLIGHTS

SLIMPACK CASE

WEIGHT
18
GRAM

Harrows
DARTS TECHNOLOGY



BLACK: 16gK2
18gK2

BLUE: 16gK2
18gK2

RED: 16gK2
18gK2

CORSAIR™ BRASS

The Corsair range of brass softtips is the perfect choice for the developing player. Sleek and stylish coloured barrels are teamed with anodised aluminium shafts and Heart flights, for aerodynamic perfection.

SPECIFICATIONS

HEART™ 8800/04.

ANODISED ALUMINIUM

BRASS

SOFT

Farbige Legierungen zieren den Körper dieses Messing-Darts, der sich eignet, die persönliche Wurftechnik auszufeilen.

"Corsair": Estos dardos de latón coloreado son perfectos para desarrollar la técnica del dardo.

Des obus laiton surlignés de couleur pour tous ceux qui veulent se perfectionner.

Lotki z kolorowymi nacięciami korpusu dla maksymalnie pewnego chwytu.

Stylove barvená mosazná tela šipek Corsair jsou perfektní volbou pro vývoj vaší hrací techniky.



14gK
16gK
18gK

MATRIX™ BRASS

The Matrix range of precision brass darts feature truly unique contoured barrels, which give the player consistently repeatable control over the darts "in flight" performance. Anodised aluminium shafts and stunning Hologram flights complete the Matrix formula.

SPECIFICATIONS

HOLOGRAM 1630.

ANODISED ALUMINIUM

BRASS

SOFT

Durch die Griffmulde mit Rillen und die angeraute Zone liegt dieser Dart sehr gut in der Hand.

Perfil con contorno para un agarre firme y constante.

Contour profilé pour une même et constante prise.

Korpusy z czarnym mosiężnym wykończeniem są idealne dla początkującego gracza.

Mimorádné tvarované telo šipky, ktoré musí padnúť dobre do ruky.



BUZZ™
BRASS

The Buzz range features extra short barrels which, when teamed with short shafts and deadly V-Wing flights, give players a sting to their game and delivers a shock to their opponent!

16gK
18gK

SPECIFICATIONS

V WING™ 7710

ANODISED ALUMINIUM

BRASS

SOFT

- Extrem kurze Barrels für mehr Zielsicherheit und Kontrolle.
- Cueros super cortos para una precisión extra y más control.
- Obus tres court pour une superbe précision et plus de contrôle.
- Super krátké korpusy zajišťující wspaniałą sterowność podczas lotu.
- Super krátká tela šipek pro vyšší presnosť hodu a snazší ovládání.



OPEN HERE

ECOLOGY NOTE:
PRINTED ON RECYCLED PAPER.

PRECISION SOFTTIP DARTS

BUZZ™



- DEADLY BARRELS
- ALUMINIUM SHAFTS
- V WING™ FLIGHTS
- SLIMPACK CASE

WEIGHT
18
GRAM

Harrow's
DARTS TECHNOLOGY



SOFTTIP

CLUB™
BRASS

The Club range of superb quality brass darts offers a fine choice of weights and styles. The precision barrels are fitted with aluminium shafts and aerodynamic flights.

16gK2
18gK2

16gR
18gR

14gK
16gK
18gK

SPECIFICATIONS

HOLOGRAM 1645

ANODISED ALUMINIUM

BRASS

SOFT

- Preiswerte Messing- Darts, komplett mit schwarzen Alu-Shafts und Hologram Flights.
- Una extensa gama de dardos de latón con aletas Hologram.
- Une gamme complète de fléchettes laiton avec des ailettes Hologram.
- Precyzyjne wyniki uzyskane dzięki najpopularnym ejszym na świecie seriom lotek z mosiężnymi korpusami.
- Mosazné šipky vysokej kvality s anodizovanými hliníkovými násadkami a letkami Hologram.



CLUB

SOFT TIP

- PRECISION BRASS
- QUALITY SHAFTS
- HI TECH FLIGHTS
- SLIMPACK CASE

weight
18
gram

Harrow's
DARTS TECHNOLOGY



16gK
18gK

PRO BRASS™ BRASS

For the beginner who wishes to practise basic throwing techniques, the Pro Brass range is the natural choice. Complete with nylon shafts, Dimplex flights and point guard, in a clear view clam pack





SPECIFICATIONS

DIMPLEX® 4016

NYLON

BRASS

SOFT

-  Sehr günstige Darts Für den Einstieg.
-  Ideal para el principiante que practica las tecnicas basicas del juego.
-  Ideal pour les debutants afin de s'initier aux techniques de base.
-  Konturowy kształt dla jednakowej i zawsze dającej się powtórzyć sterowności.
-  Vynikaj ici pro začatečníky, kteří se chtějí seznámit se základní technikou hodů.

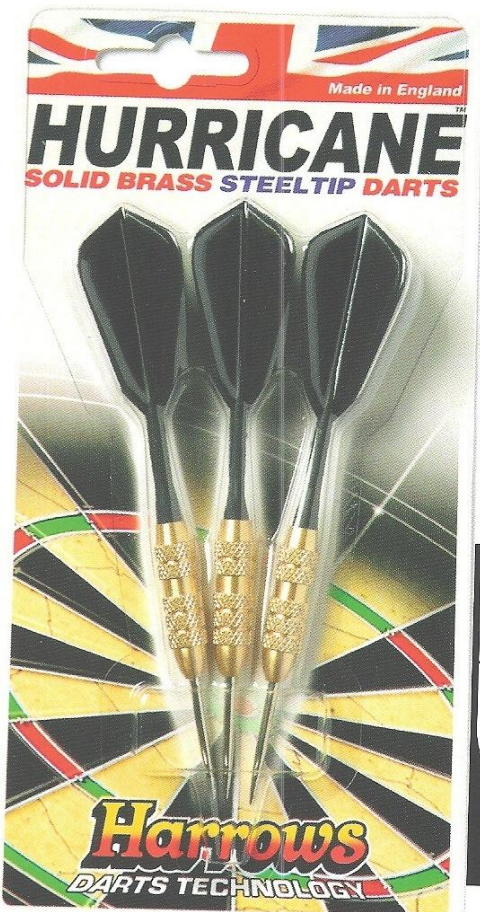

HURRICANE™ BRASS





Hurricane precision made solid brass darts are the perfect introduction to the world of Harrows Darts and they are ideal for social and recreational play.

SPECIFICATIONS

HIGH GRADE
POLYMER

BRASS

SOFT

-  Sehr günstige Darts Für den Einstieg.
-  Ideal para el principiante que practica las tecnicas basicas del juego.
-  Ideal pour les debutants afin de s'initier aux techniques de base.
-  Super krótkie korpusy zapewniające wspaniałą sterowność podczas lotu.
-  Vynikaj ici pro začatečníky, kteří se chtějí seznámit se základní technikou hodů.

SOFTIP

INTRODUCING OUR STUNNING NEW ACCESSORY BLISTER CARD

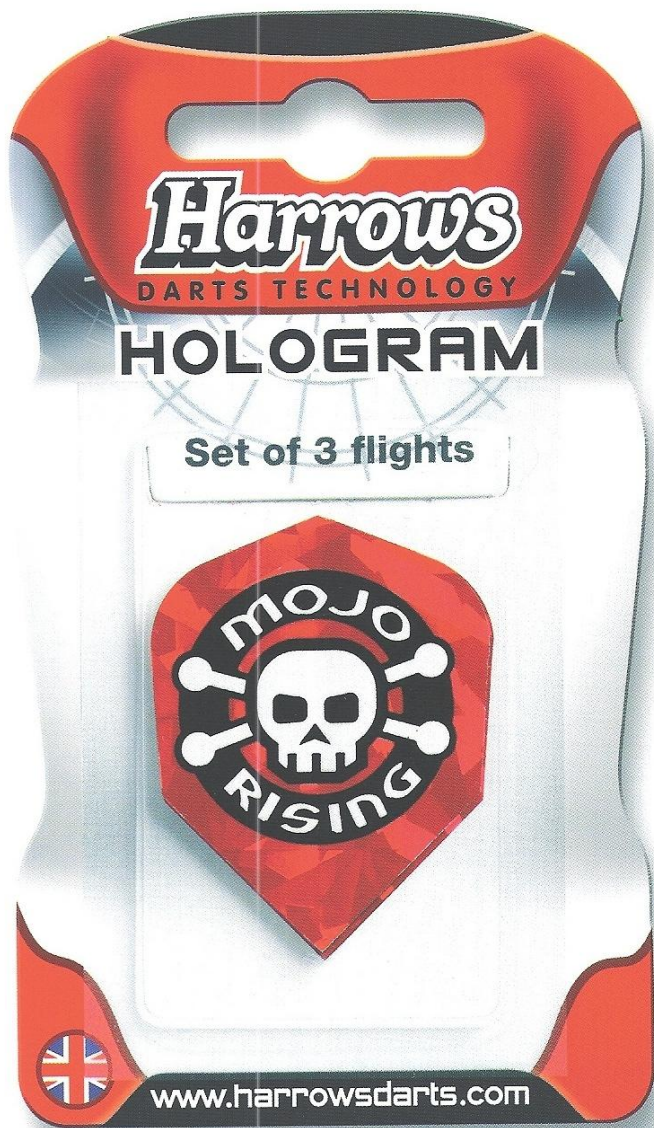

ACCESSORIES

MODULAR PERFECTION
Combined with our modular merchandisers the new packs make a dramatic impact at retail

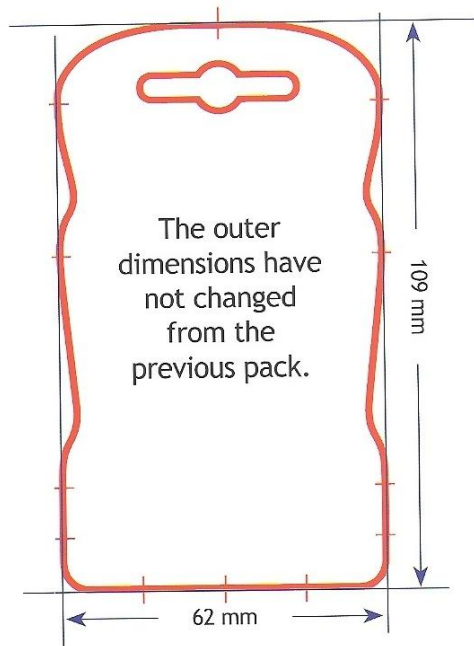

The new card has the following improvements and features:

- High impact colour graphics
- Exclusive look
- Ergonomic shape





STEELTIP MINI DARTS
Total length: 70mm.
For use on all bristle boards. Big fun for everyone!

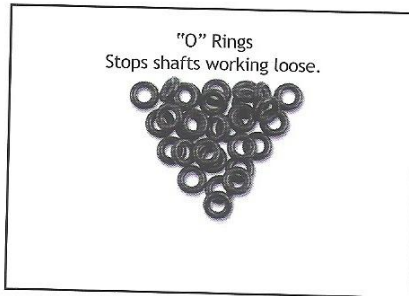

"O" Rings
Stops shafts working loose.



SOFTIP MINI DARTS
Total length: 67mm.
For use on all softtip boards. Big fun for everyone!

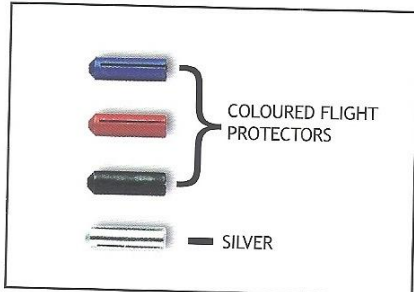

COLOURED FLIGHT PROTECTORS

SILVER

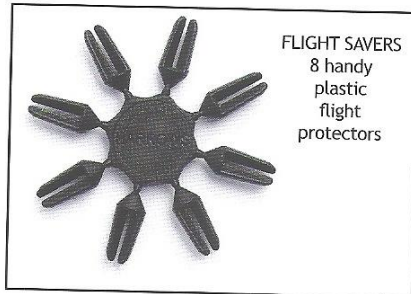

FLIGHT SAVERS
8 handy plastic flight protectors

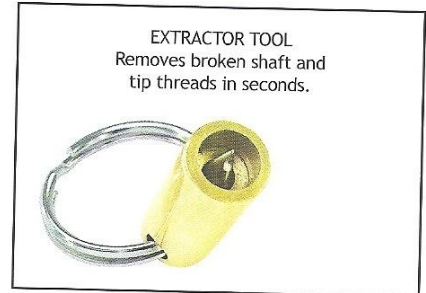

EXTRACTOR TOOL
Removes broken shaft and tip threads in seconds.

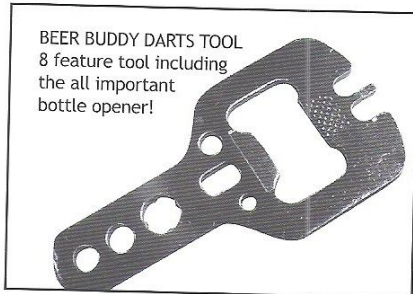

BEER BUDDY DARTS TOOL
8 feature tool including the all important bottle opener!

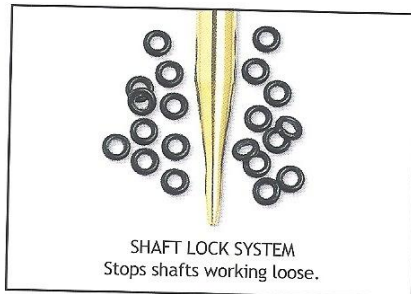

SHAFT LOCK SYSTEM
Stops shafts working loose.

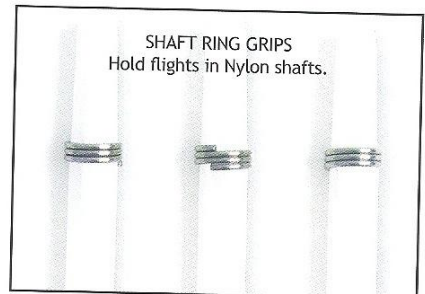

SHAFT RING GRIPS
Hold flights in Nylon shafts.

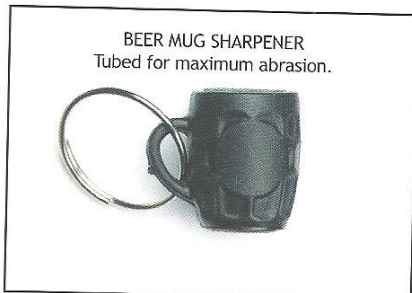

BEER MUG SHARPENER
Tubed for maximum abrasion.

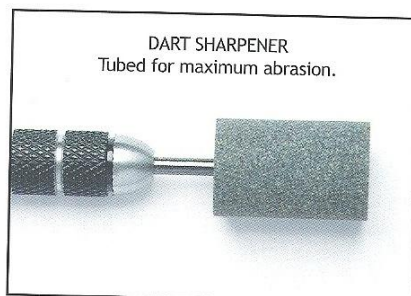

DART SHARPENER
Tubed for maximum abrasion.



SHARPENER KEYRING
Handy leather caddy.

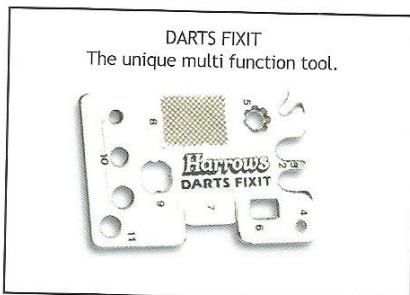

DARTS FIXIT
The unique multi function tool.

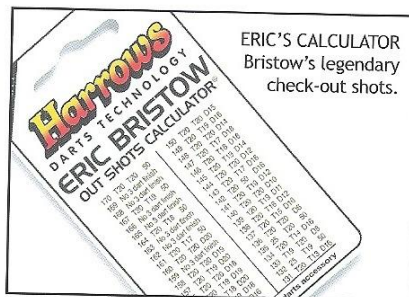

ERIC'S CALCULATOR
Bristow's legendary check-out shots.



FINGER GRIP
Non slip wax

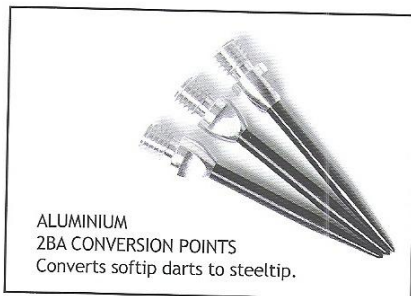

ALUMINIUM 2BA CONVERSION POINTS
Converts softtip darts to steeltip.

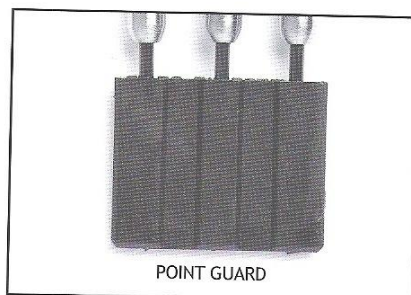

POINT GUARD



BRASS 2BA CONVERSION POINTS
Converts softtip darts to steeltip.

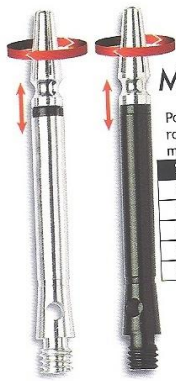

MAGNET™

Polar force attraction. Top rotates if following dart makes contact.

SIZE	2BA	COLOUR
medium	2BA	black
medium	2BA	silver
short	2BA	black
short	2BA	silver
spare tops		natural

COLETTE™

Anodised aluminium. Ultimate flight grip. Locking top.

SIZE	2BA	COLOUR
medium	2BA	assorted
short	2BA	assorted
spare tops		natural

Screw to tighten

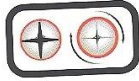

ATLANTIS™

Anodised aluminium. Unique profile. Diamond cut.

SIZE	2BA	COLOUR
medium	2BA	assorted
short	2BA	assorted



TITANIUM™

Lightweight. Ultra slim. Strong.

SIZE	2BA	COLOUR
medium	2BA	natural
short	2BA	natural
spare tops		natural



SAVAGE™

Knurled aluminium shaft. Firm bond to barrel. Extra grip.

SIZE	2BA	COLOUR
medium	2BA	natural
short	2BA	natural



QUIVER™

Flexible polycarbonate. Reduceable length. Aluminium top.

SIZE	2BA	COLOUR
medium	2BA	black
spare tops		natural



Rotating top dramatically reduces flight deflections

ELECTRO™

Anodised aluminium. Awesome design. Visual dynamics.

SIZE	2BA	COLOUR
medium	2BA	assorted
short	2BA	assorted



REVOLVER™

Anodised aluminium. Top rotates. Less deflections.

SIZE	2BA	COLOUR
medium	2BA	assorted
short	2BA	assorted



TEKNALITE™

Anodised aluminium. Aerodynamic fluting. Vertical diamond cut.

SIZE	2BA	COLOUR
medium	2BA	assorted
short	2BA	assorted

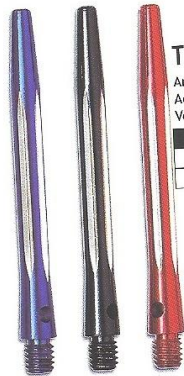

AZTEC™

Anodised aluminium. Spectacular style. Diamond cut.

SIZE	2BA	COLOUR
medium	2BA	assorted
short	2BA	assorted

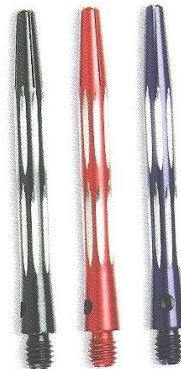

TRIAD™

Anodised aluminium.
Spectacular styling.
Diamond cut

SIZE	COLOUR	
medium	2BA	assorted
short	2BA	assorted



ANODISED

Anodised aluminium.
Alamo shape.
Sleek styling.

SIZE	COLOUR	
medium	2BA	assorted
short	2BA	assorted



ALUMINIUM

Alamo shape.
Durable. Slimline.
Low profile.

SIZE	COLOUR	
medium	2BA	natural
short	2BA	natural
ex. short	2BA	natural



Cross hole
locking system on
all anodised and
aluminium shafts

KERAMIC™

Super tough, super strong.

SIZE	COLOUR	
medium	2BA	white
midi	2BA	white
short	2BA	white



GRAFLITE™

Improved balance.
Weight Reduction Zones

SIZE	COLOUR	
midi	2BA	black



TIGER™

Anodised aluminium.
Alamo shape. Pinstriped.

SIZE	COLOUR	
medium	2BA	assorted
short	2BA	assorted



ALAMO®

Aluminium fixed top.
Polycarbonate linker

SIZE	COLOUR	
medium	2BA	black
medium	2BA	red
medium	2BA	white
short	2BA	black
short	2BA	red
short	2BA	white



Rotating top
dramatically
reduces flight
deflections

GYRO™

Aluminium rotating top.
Polycarbonate linker.
Less deflections.

SIZE	COLOUR	
medium	2BA	black
medium	2BA	red
short	2BA	black
short	2BA	red

Flight ring grips

RAINBOW

A spectrum of neon nylon shafts
Ring grip retains flight.

SIZE	COLOUR	
medium	2BA	pink
medium	2BA	blue
medium	2BA	yellow
short	2BA	pink
short	2BA	blue
short	2BA	yellow



NYLON

World leader. Ultra strong.
Ring grip retains flight.

SIZE	COLOUR	
medium	2BA	black
medium	2BA	white
medium	2BA	blue
medium	2BA	red
midi	2BA	black
midi	2BA	white
short	2BA	black
short	2BA	white
short	2BA	blue
short	2BA	red
ex.short	2BA	black
ex.short	2BA	white
shaft rings		natural



GRAFILITE

State of the art sport performance laminate • Rigid 90° flight wings • Now available in Fantail and Mini



7000



7001



7002



7003



7004



7005

MARATHON GOLD

Marathon Gold is a radical fusion of a unique thermo laminated material, which is 33% thicker than a standard flight and the patented Dimplex construction concept • Increased strength, longer life and a true 90 degree wing angle.

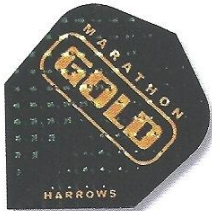

2300



2301



2302

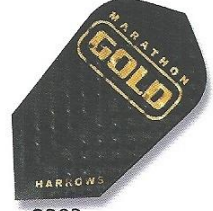

2303



2304



2305

TRIAD

The extra wing surface area (41.4cm³) gives added lift and a steady trajectory. Will assist both steel and softtip players alike.

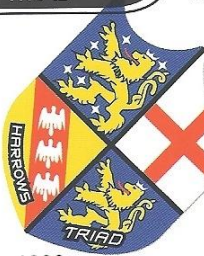

6000



6001



6002



6003



6004



6005

DIMPLEX MARATHON

The two flight concepts which revolutionised darts are combined in this iconic series.



1900



1901



1902



1903



1904

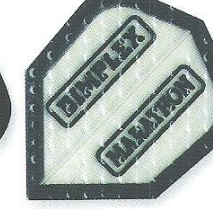

1905

SEXY GIRLS

Manufactured to Harrows "strict" standardsfantasytastic!



2200

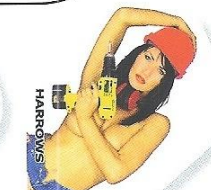

2201



2202



2203



2204



2205

ENGLISH PUBS

Celebrate Britain's drinking heritage with these classic pub signs



2100



2101



2102



2103



2104



2105

FLIGHTS

The world beating concept • 33% thicker for extra strength and rigidity

MARATHON



1500



1501



1502



1503



1504



1505



1506



1507



1508

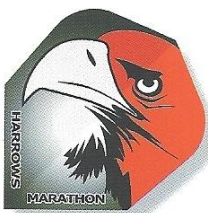

1509



1510



1511

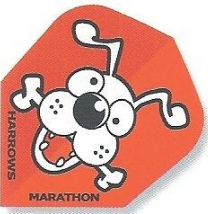

1512



1513



1514



1515



1516

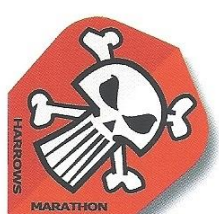

1517



1518

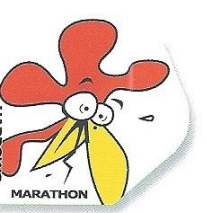

1519



1522



1523

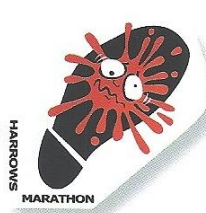

1524



1525



1526



1527P



1528P



1529P

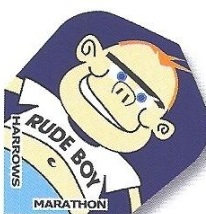

1530



1531



1532

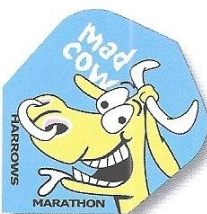

1533

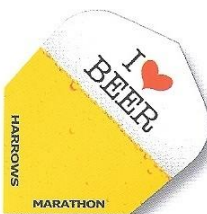

1534



1535



1536



1537

FLIGHTS

LOGLIFE

Super tough woven fibre flights that just keep on going.

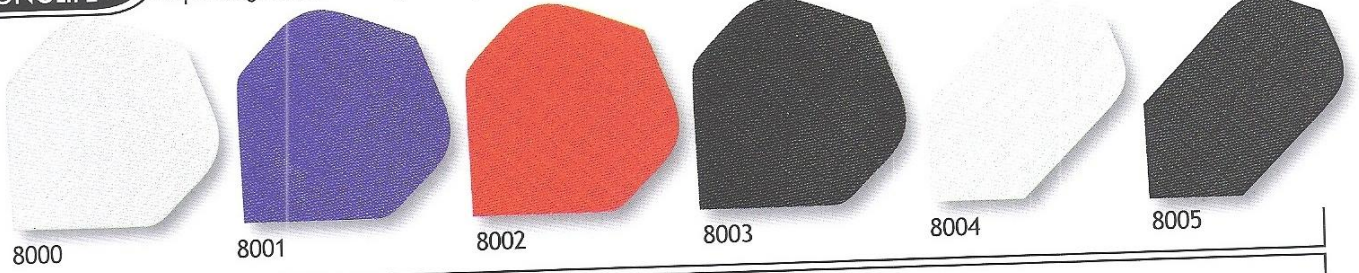

HEART

Radical smooth-flow flight characteristics



COMBAT

Radical shape • Stunning 3D material



FANTAIL

Innovative aerodynamic shape • Eye catching designs



VORTEX

Classic feather design • Superb holograms

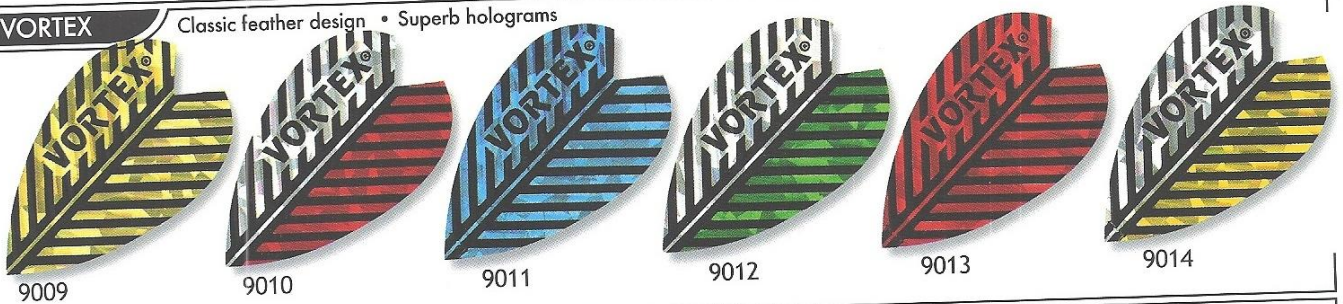

VORTEX 353

15% smaller than Vortex™ • Classic feather design

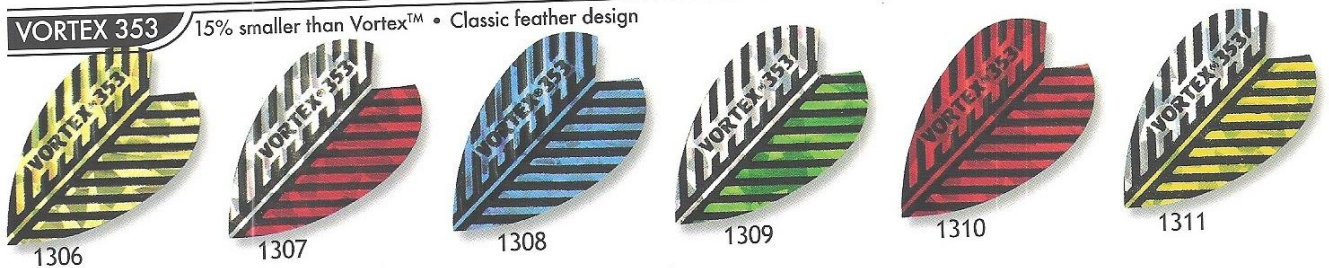

Stunning hologram materials combined with world beating designs for optimum visual impact

HOLOGRAM



1600

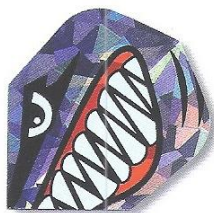

1601



1602



1603



1606

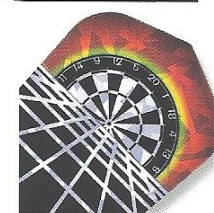

1613



1614

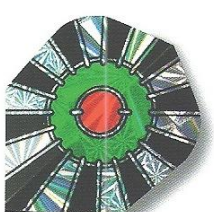

1617



1618



1620



1621



1622



1624



1625



1626



1628



1630



1631



1633

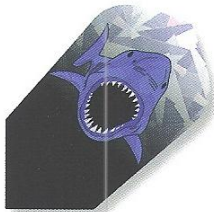

1634



1636



1637



1638



1639



1640



1641



1642

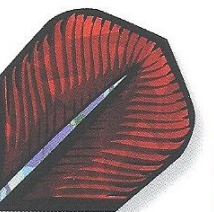

1643



1645



1647



1648



1649



1661



1671



1672

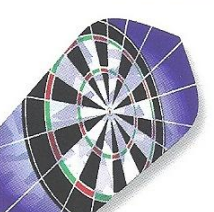

1682

FLIGHTS

FLIGHTS

43

DIMPLEX

The original flight construction concept which revolutionised the sport



4000

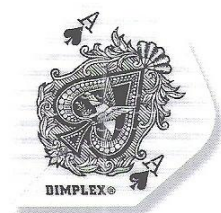

4002



4003



4004



4004P

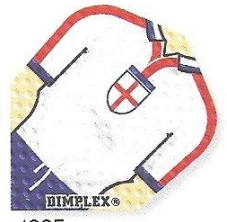

4005



4006



4008

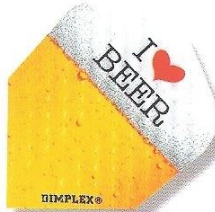

4009

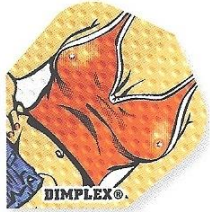

4011



4012



4014



4015P

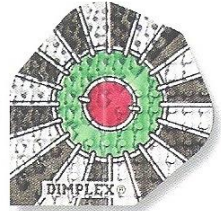

4016



4017



4020



4022

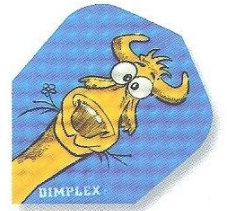

4023



4024

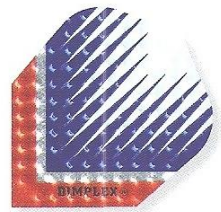

4025



SAMURAI
4026



4027

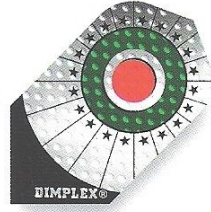

4028



4030



4031



HELL CAT
4035



4037



MGN 1986
4039



4046



RAZOR
4049



4120



4195



4195P



4196



4197



4198

Unique aerodynamic shape for added lift • Spectacular collection of superb designs

V WING



7700

7701

7703

7709

7710

7715

Dimplex Design Dynamics • Stunning refractory material

DIMPLEX 3D

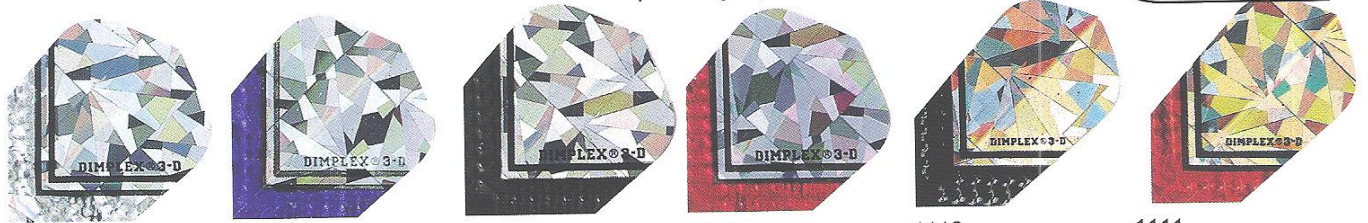

1101

1102

1104

1105

1110

1111

High grade transparent polyester

POLYPRINT

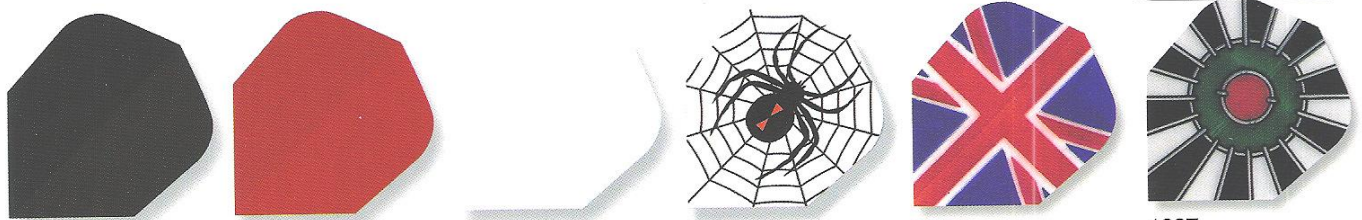

1000

1001

1002

1004

1005

1007

A multitude of striking graphics for added visual appeal

QUADRO



2000

2001

2002

2003

2004

2009

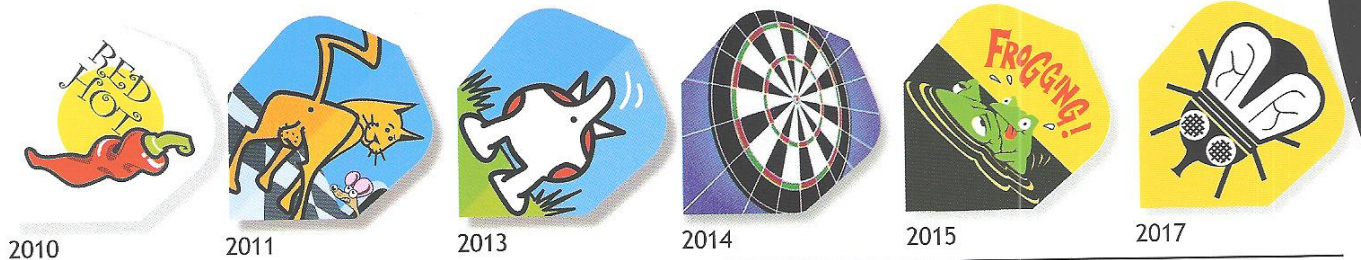

2010

2011

2013

2014

2015

2017

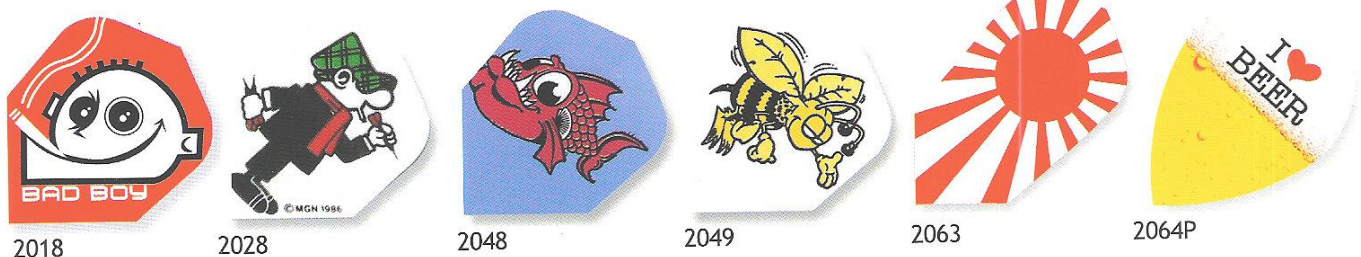

2018

2028

2048

2049

2063

2064P

FLIGHTS

FUNK aDeLie

...get down on it

Another first from the world's grooviest dart flights manufacturer

burp belch

MINGER!

fingerlickin' good



RUDE BOY

FUNKY Flights

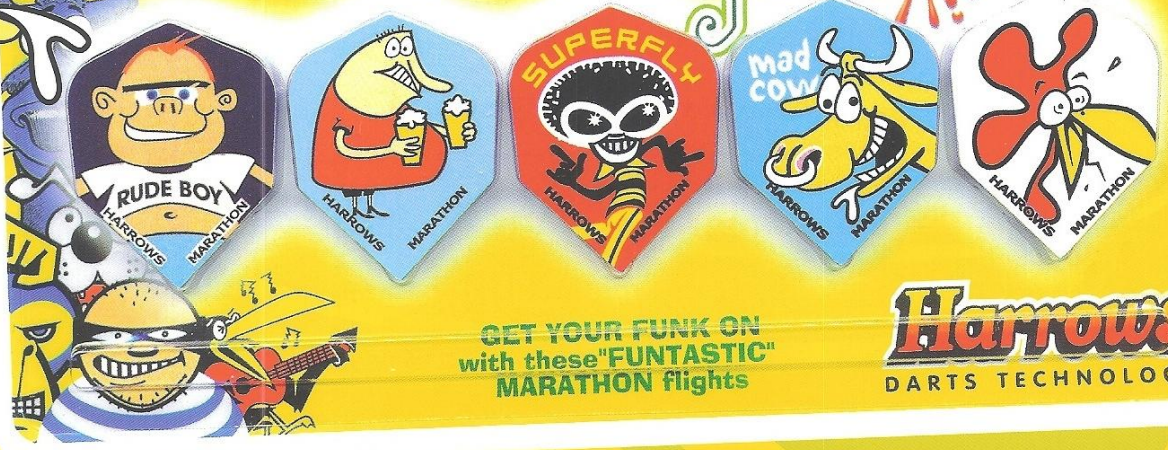

GET YOUR FUNK ON with these "FUNTASTIC" MARATHON flights

Harrows
DARTS TECHNOLOGY

www.harrowsdarts.com

Harrows

DARTS TECHNOLOGY

GET YO' FUNK ON!

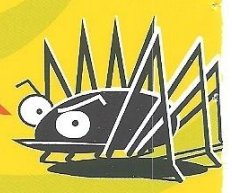

FLIGHT MULTI PACKS

SYSTEM 5 FLIGHTS
The revitalised flight system allows the player to experiment with the 5 sets to find one that best suits their throwing style.



FUNKY FLIGHTS
"Get down on it", with these funtastic flights. These ultra strong long life flights are constructed from Marathon material, a unique 33% thicker construction concept, which results in extra rigidity and increased durability.



ENGLISH PUBS FLIGHTS
Celebrate England's drinking heritage with these classic pub sign flights. Wherever the player is in the world, they can enjoy their game of darts with this reminder of where the sport was born, the traditional English Pub.



RADICAL FLIGHTS SYSTEM
A unique combination of 5 sets of leading edge designs and shapes, for players to experience the ultimate in aerodynamic performance.



VARIETY PACK-10 SETS
Check out these superb quality dart flights. They are supplied as 30 pieces (10 sets), to give the player a maximum combination of designs, shapes, colours and textures. N.B. Pack contents will change from time to time.



“THE IDEAL GIFT OR IMPULSE PURCHASE”

THESE 5 FLIGHT COMBO SETS OCCUPY THE SAME SPACE NORMALLY USED TO SELL 3 INDIVIDUAL SETS = 40% EXTRA VOLUMETRIC PROFIT FROM ONE S.K.U.

ALL PRODUCTS ON THIS PAGE FIT OUR MODULAR MERCHANDISERS

Check out our wallets, 5 of which are branded with our new 3D flexible rubber logo



OUR COMPLETE NEW AND UPGRADED WALLET COLLECTION

The handy Vector wallet features 4 compartments for flights and a velcro closed pocket for shafts, tips and sundry other accessories.

Darts can be stored in the integral location pockets in the base, with flights fitted, ready for matchplay action.

Space-age easy clean material

4 compact accessory pockets

Darts, accessories and money not included

and they feature cool



Sylish Airtex pocket

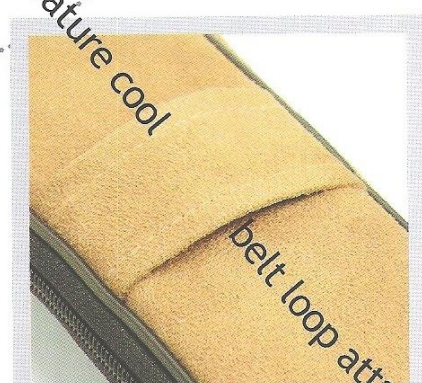

belt loop attachment

Belt loop attachments feature on Magnum, Vector, Dimplex, Big Zipper and Mega Zipper

WALLETS

DIMPLEX WALLET
Darts can be stored with flights fitted.



BIG ZIPPER WALLET
Darts can be stored with flights fitted.



LEATHER 4 FOLD WALLET
Superb quality leather, with velcro closure.

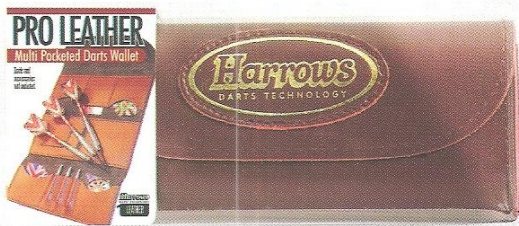

MAGNUM WALLET
Extra capacity. Suede finish.

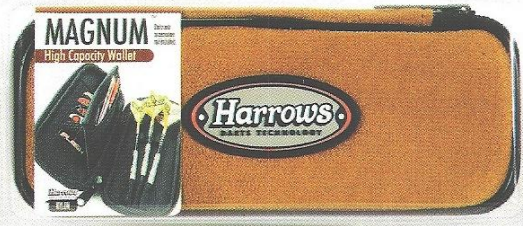

PRO WALLET
Leatherette material with velcro closure.

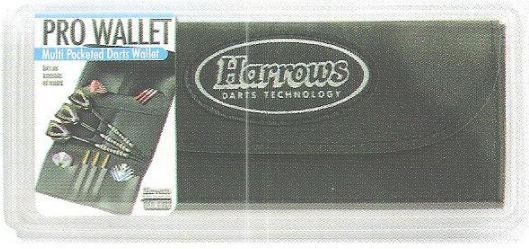

LUXURY CASE
Darts and accessories not included.



MEGA WALLET
Capacity for 2 sets of darts, 6 accessories and there is a security section for money or credit cards. Full zip closure. Complete with hanging header card.



Contents not included.

VECTOR WALLET
Space age design!





H-Tip The future today!

Manufactured In England From Grafftex - The Space Age Super Composite.

Resonance Damper System Test

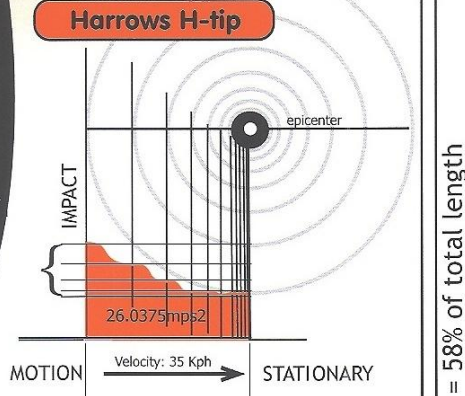
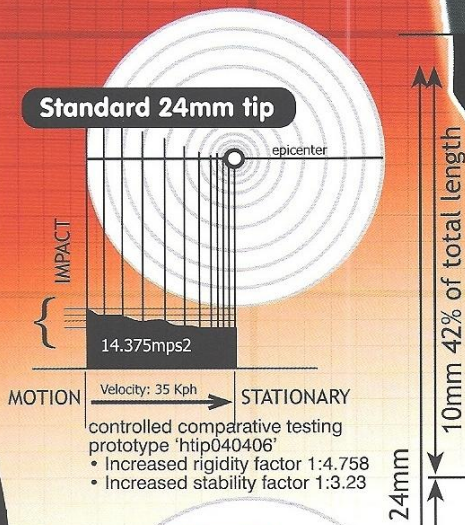

BFG Independent Research & Testing



Available in 2ba
Black or White

Why H Tip?

A traditional dart softtip of 26mm external length has a gradually tapered 19mm front section, of which 7mm penetrates the surface of the dartboard. The shockwaves created by the entry of the dart into the board cause extreme vibration to travel back up the tip. (see fig.1) This has two negative effects:

- 1) Tip life is reduced, as stress fractures occur at the point where the tip widens to go into the 'nose' at the front of the dart.
- 2) Player concentration is reduced as the excessive vibration and the continual need to replace broken tips takes their focus off the game.

The new H-Tip features a re-inforcing Shock Absorption Zone (S.A.Z.), which is located 14mm from the end of the tip. (see fig.2). The combination of the S.A.Z. and the unique Grafftex composite material results in a super-tough tip

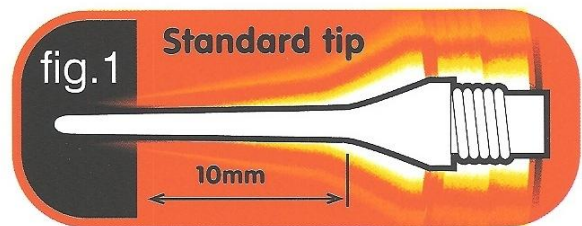

Reduces vibration by 52%
for longer tip life and
improved concentration!

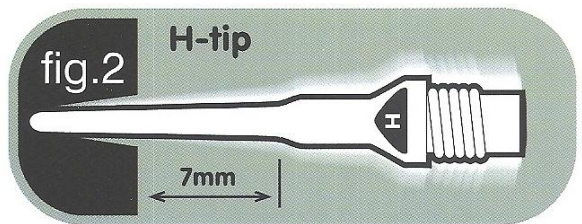

Shock Absorption Zone (S.A.Z)

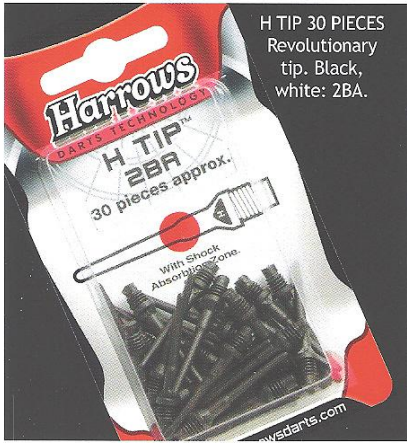

H TIP 30 PIECES
Revolutionary tip. Black, white: 2BA.



DIMPLE 30 PIECES
Classic tip. Black, white: 2BA, black 1/4.

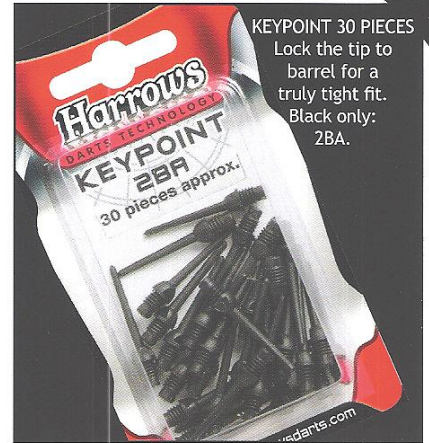

KEYPOINT 30 PIECES
Lock the tip to barrel for a truly tight fit. Black only: 2BA.



H TIP BULK
Supplied in clear view 1000 piece bags. Black, white: 2BA.

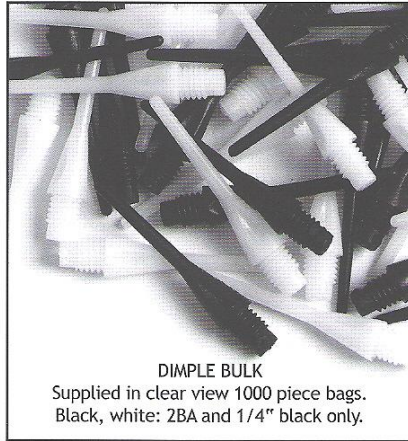

DIMPLE BULK
Supplied in clear view 1000 piece bags. Black, white: 2BA and 1/4" black only.



KEYPOINT BULK
Supplied in clear view 1000 piece bags. Black, white: 2BA and 1/4" black.

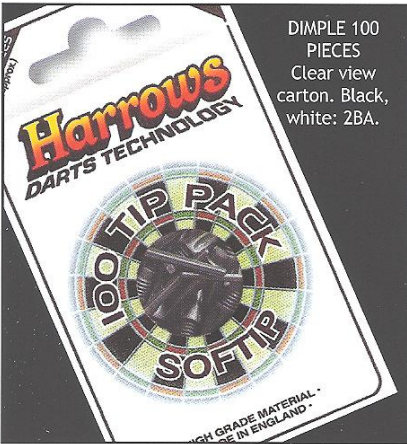

DIMPLE 100 PIECES
Clear view carton. Black, white: 2BA.

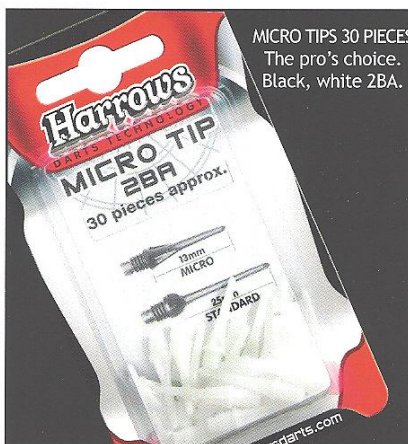

MICRO TIPS 30 PIECES
The pro's choice. Black, white 2BA.



MICRO BULK
Supplied in clear view 1000 piece bags. Black and white: 2BA

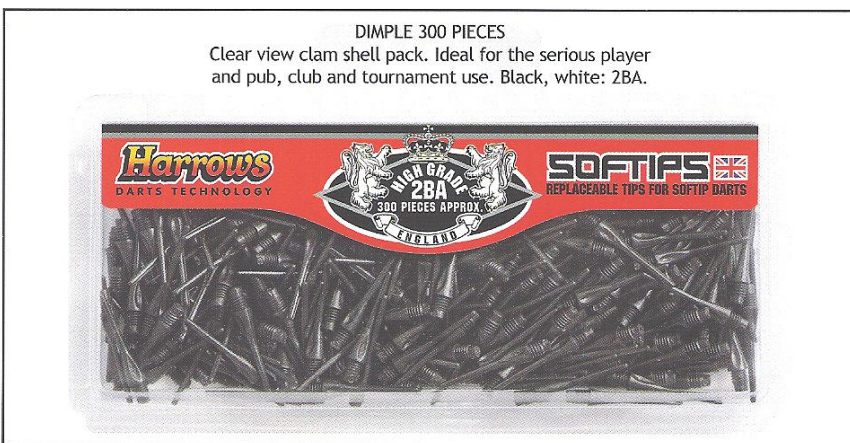

DIMPLE 300 PIECES
Clear view clam shell pack. Ideal for the serious player and pub, club and tournament use. Black, white: 2BA.

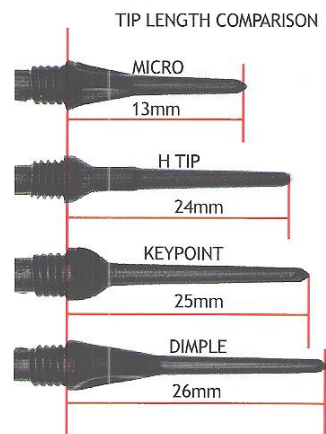

CABINET
 Light oak finish. Scoreboards inside doors. Holds all sizes of dartboard. Reinforced corner brackets.
 NB: Dartboard not included

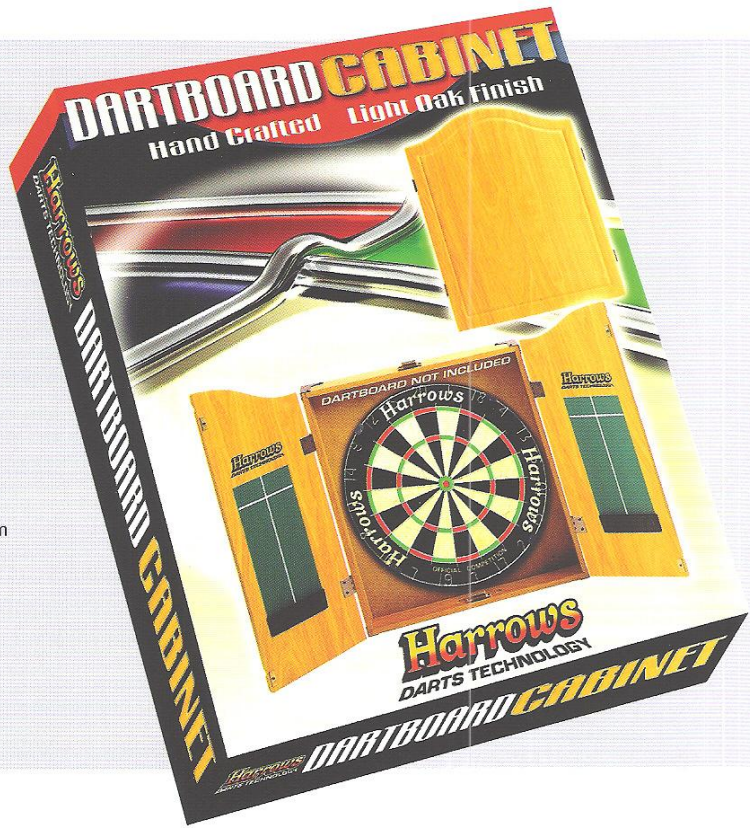
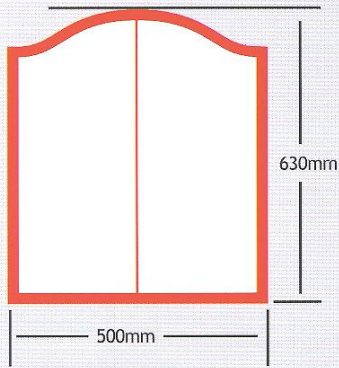

PROFESSIONAL DARTS MAT

Heavy duty rubber(10kg). Printed with Harrows logo and international throw lines. Supplied in a striking colour display carton.

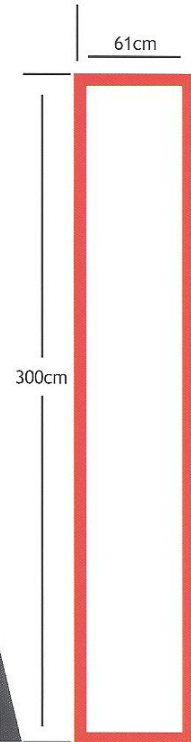
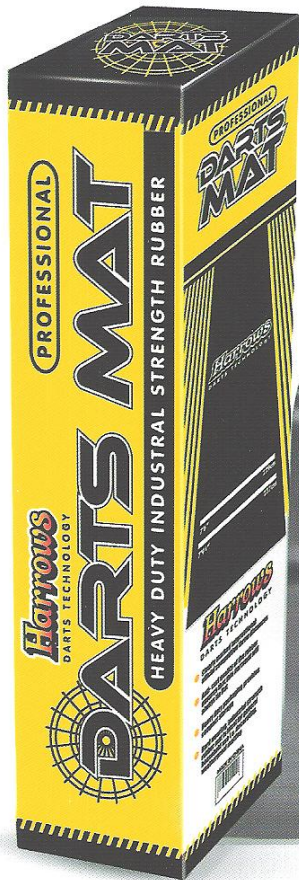

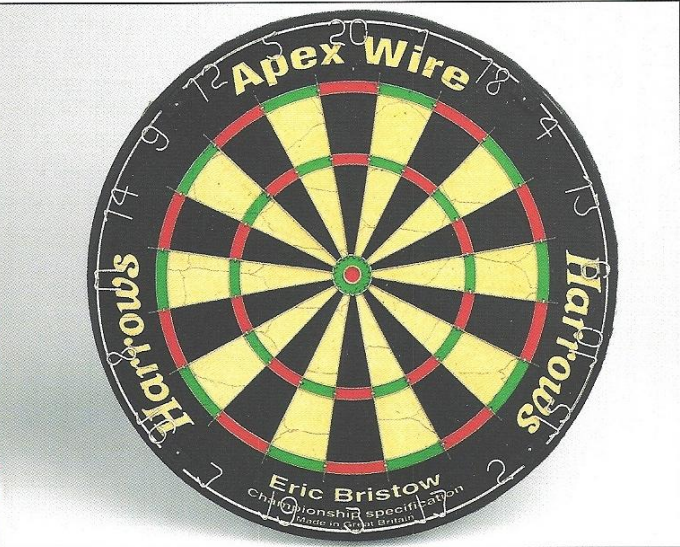
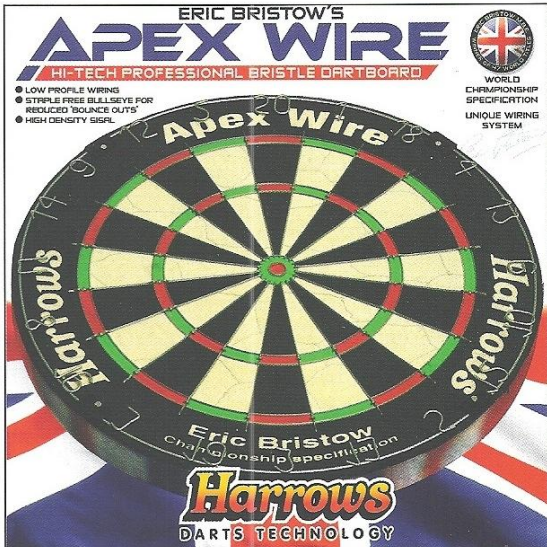

ERIC BRISTOW APEX™ WIRE BRISTLE. The Apex board features unique: "edge-on" profile wiring and staple free bullseye, which result in reduced bounceouts and higher scoring averages.



OFFICIAL COMPETITION BRISTLE. Harrows Official Competition Bristle Board is manufactured to International Matchplay standards. The staple free bullseye reduces the chance of dart bounceouts and it is the bullseye of choice for sharp shooters worldwide.

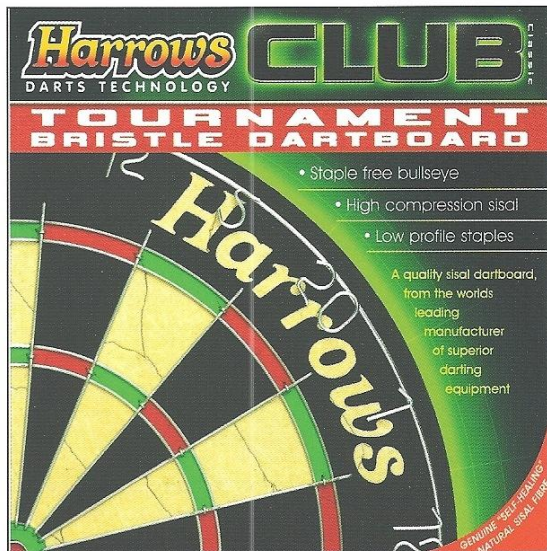

CLUB CLASSIC BRISTLE. Quality bristle dartboard for use in pub, club or home environments. Tournament size and specification, complete in a striking colour display carton. Not available in the U.K



ELECTRO 180 SOFTTIP DARTGAME
 The "people and furniture friendly" electronic dartgame for 1-8 players or teams. Programmed with 21 Popular Games, with more than 136 variations, including darts handicap programming, for players of all ages and abilities. Choose from 301-1001, Shoot-out, Round-the-Clock, Count-Up, High-Score, Overs & Unders, Cricket and many more! Bonus features include: Automatic scoring, sound effects (optional), automatic turn-off, with memory function and alarm clock. Complete with 6 "Silver Arrow" style darts and 30 extra tips.

- o Classic 301 to 1001
- o Round The Clock
- o High Score
- o Shoot-Out
- o Shanghai
- o Count Up
- o Halve-It
- o Cricket

- Battery Powered: 3X AA Batteries (not included).
- Auto Sleep Functions: To save battery life, game switches off if not played on for 5 minutes.
- Resume Play Memory: Saves a game if not completed, giving you the option to resume, if desired.
- Voice Reward Sounds: Recognition of high scores and clock outs. (This is an optional feature).
- Multi Lingual Instruction Manual.
- Digital Clock & Alarm.

Harrows
 DARTS TECHNOLOGY

"100% FUN
Family Sport
 Action!
 ERIC BRISTOW M.B.E.
 5 TIMES WORLD
 CHAMPION"
**6 FREE
 DARTS**
 and 30 spare tips

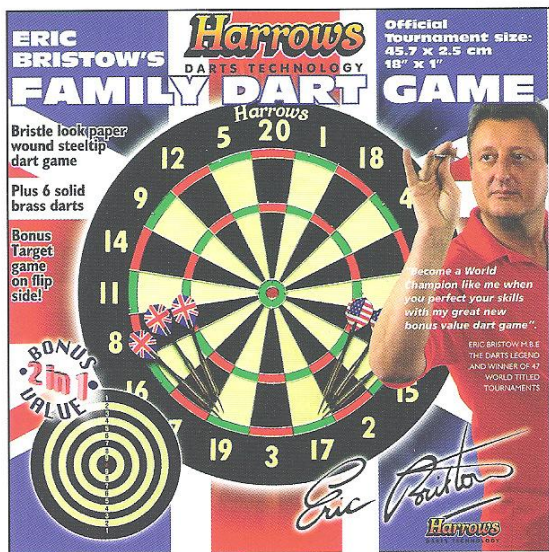

BRISTOW FAMILY DART GAME. Fun for all the family, this tournament sized paper coil steeltip game comes complete with 6 X 18g brass darts, in a fully explanatory and visually stunning carton. Bonus value target game on reverse.